

TJ  
7  
M3  
V.67

UC-NRLF



B 3 018 807

# MACHINERY'S REFERENCE SERIES

EACH NUMBER IS A UNIT IN A SERIES ON ELECTRICAL AND STEAM  
ENGINEERING DRAWING AND MACHINE DESIGN AND SHOP PRACTICE

No. 67

A Dollar's Worth of Condensed Information

# Steam Boilers

Price 25 Cents

## CONTENTS

|  |    |
|--|----|
| Steam Generation - - - - -                     | 3  |
| General Proportions of Boilers - - - - -       | 13 |
| Classification and Types of Boilers - - - - -  | 16 |
| Design of Horizontal Tubular Boilers - - - - - | 29 |
| Boiler Testing - - - - -                       | 46 |

The Industrial Press, 49-55 Lafayette Street, New York  
Publishers of MACHINERY

COPYRIGHT, 1911. THE INDUSTRIAL PRESS, NEW YORK

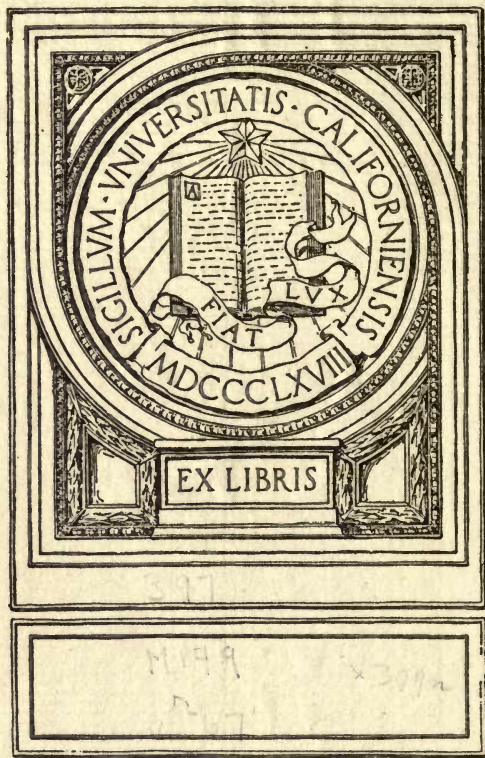

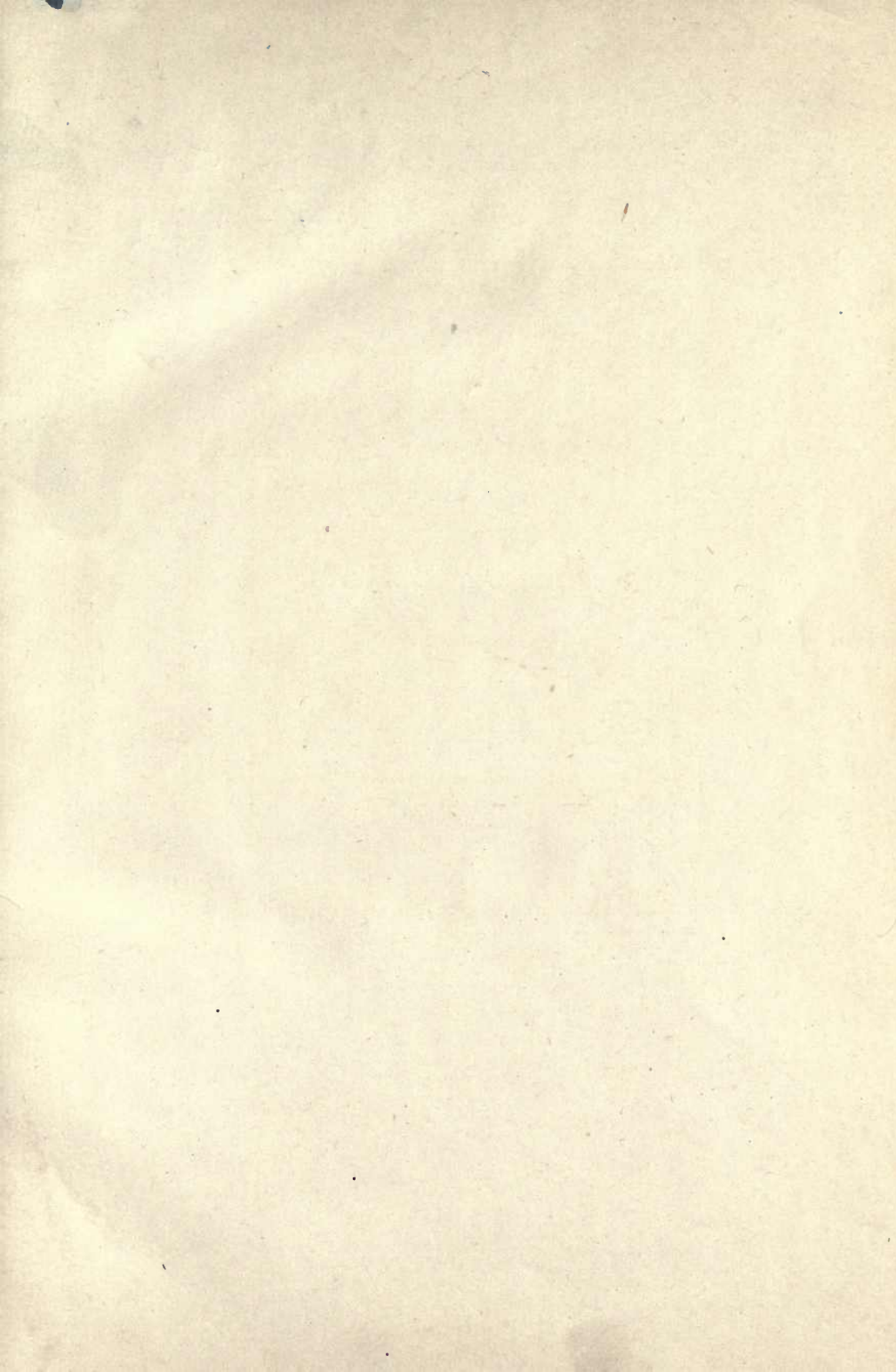

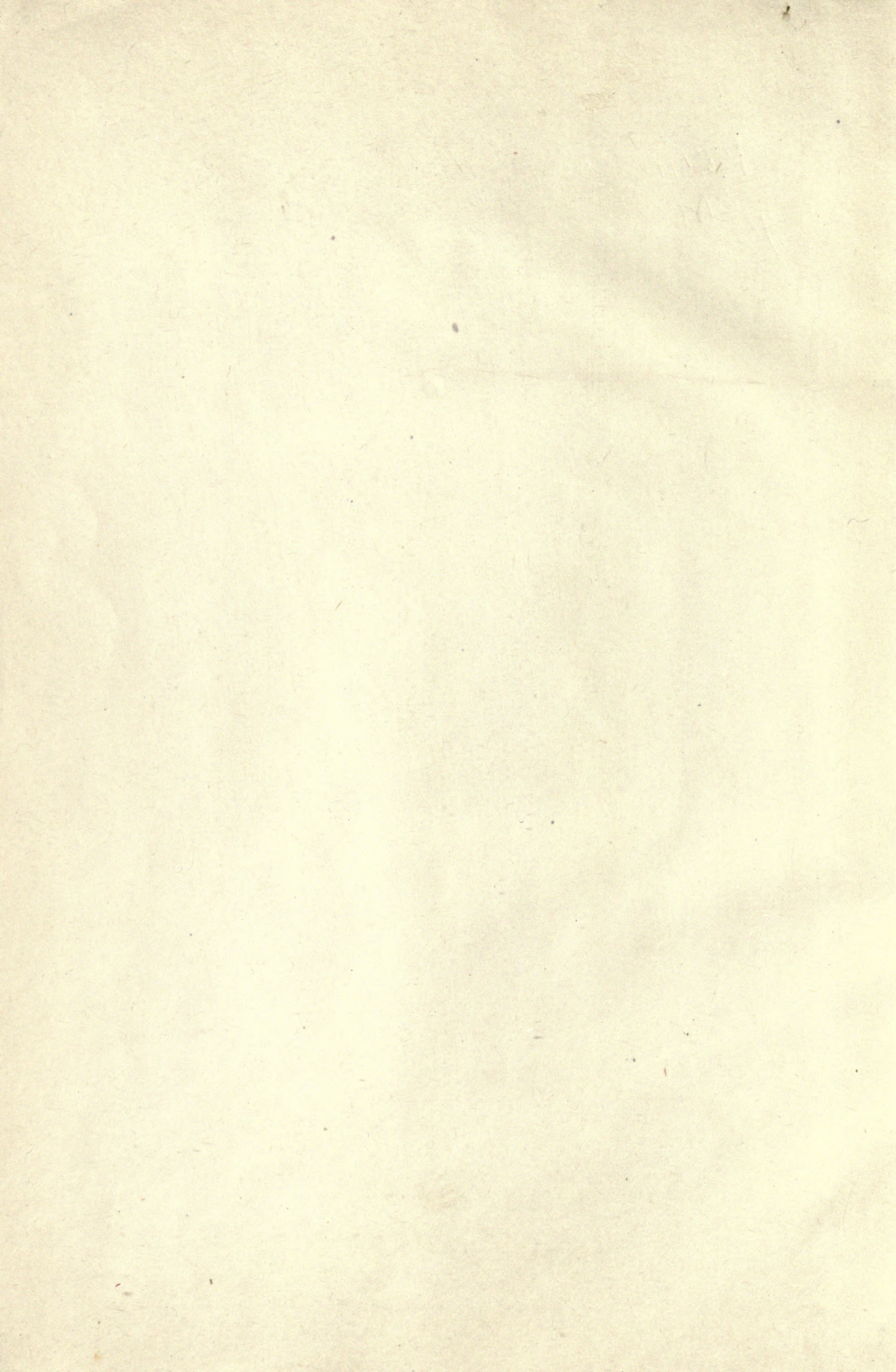

# MACHINERY'S REFERENCE SERIES

EACH NUMBER IS A UNIT IN A SERIES ON  
ELECTRICAL AND STEAM ENGINEERING  
DRAWING AND MACHINE DESIGN  
AND SHOP PRACTICE

NUMBER 67

## STEAM BOILERS

### CONTENTS

|  |    |
|--|----|
| Steam Generation - - - - -                     | 3  |
| General Proportions of Boilers - - - - -       | 13 |
| Classification and Types of Boilers - - - - -  | 16 |
| Design of Horizontal Tubular Boilers - - - - - | 29 |
| Boiler Testing - - - - -                       | 46 |

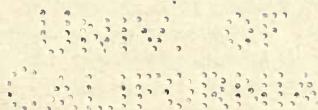



## CHAPTER I

### STEAM GENERATION

Heat is recognized by the bodily sensation which it produces. Some objects feel hot and others cold, according to the relative amount of heat which they contain. Heat is supposed to be due to the vibration of the molecules of a substance, and the intensity of the heat, or the temperature, varies with the velocity and extent of these vibrations.

Temperature is measured in degrees. In the Fahrenheit (F.) scale, which is commonly used in this country, the bulb of the thermometer is first placed in the water from melting ice, and then in steam which is being evaporated under atmospheric pressure, and the height to which the mercury rises divided into 180 degrees. The temperature of melting ice, or the *freezing point*, as it is called, is marked 32 degrees above zero, which makes the *boiling point* temperature  $32 + 180 = 212$  degrees above zero. In the Celsius system, the Centigrade (C.) scale is used. In this case, the freezing point is marked 0, and the boiling point, 100 degrees. The methods of conversion from one scale to the other are indicated by the following equations:

$$F = (1.8 \times C) + 32,$$

$$C = 5/9 \times (F - 32),$$

in which,

$C$  = reading on Centigrade scale,

$F$  = reading on Fahrenheit scale.

#### Heat Unit and Latent Heat

The measure or unit of heat is the quantity required to raise the temperature of 1 pound of water 1 degree, at its point of greatest density. Although this occurs at about 39 degrees F., it is customary, in ordinary computations, to disregard the temperature, and to define a heat unit or thermal unit (T. U.) as simply the quantity of heat required to raise the temperature of 1 pound of water 1 degree.

Latent heat is the heat which disappears when a solid is changed to a liquid, or a liquid to a gas, the former being called the latent heat of fusion, and the latter, the latent heat of evaporation. The heat which disappears in this manner is converted into mechanical work, and is used in tearing apart the molecules, and hence, produces no change in the temperature of the substance. When the gas changes back to a liquid, or the liquid to a solid, the latent heat is again given out. The action described may be illustrated by the melting of ice into water, and the evaporation of the water into steam. When heat is applied to a piece of ice in an open vessel, it gradually melts, but the temperature of the water remains at 32 degrees until all of the ice has been melted, the heat having been used in the process of chang-

ing the ice into water. If heat is still applied, the temperature of the water will rise until it reaches 212 degrees, at which point evaporation takes place, and although heat is constantly applied, the temperature of the water remains constant until it is all evaporated into steam. If the steam were collected and condensed, and the water cooled to 32 degrees and frozen, all of the heat which had been supplied would again be given out. Latent heat plays an important part in the operation of a boiler and the generation of steam.

#### Convection, Conduction and Radiation

The currents set up within a liquid, due to temperature differences in different parts, are called convection currents, and are important in causing the water to circulate over the heating surfaces within a steam boiler. The passage of heat from one body to another, or from one part of the same body to another part at a lower temperature, is called conduction. Heat from the furnace reaches the water within a boiler by conduction through the plates, and is diffused throughout the entire volume by the same process, assisted by convection. Heat which is transmitted through the air by the vibration of the surrounding ether is called radiant heat. This does not warm the air directly, but is absorbed by the objects in its path, which in turn give it up to the air by conduction. Much of the heat absorbed by the plates directly above the fire in a boiler is radiant heat.

#### Steam

Steam is water changed to a gaseous form by the application of heat. It may be *saturated*, *superheated*, *dry*, or *wet*. Saturated steam is that which is in the presence of, and at the same temperature as, the water from which it was evaporated. There is always a definite relation between the pressure and temperature in the case of saturated steam. For example, saturated steam evaporated under atmospheric pressure always has a temperature of 212 degrees. Steam evaporated under a pressure of 5.3 pounds (gage) has a temperature of 227.9 degrees F.; under 10.3 pounds pressure, 240 degrees F.; under 100.3 pounds, 337.8 degrees F., and so on.

Superheated steam is that which has been heated to a temperature above that due to its pressure. Steam is superheated by passing it through pipes or coils exposed to the hot gases from the furnace, after it leaves the steam space of the boiler. Certain types of engines and turbines are more efficient when supplied with superheated steam, for reasons which cannot here be explained. Dry steam is that which contains no moisture. It may be either saturated or superheated. Wet steam, so called, contains more or less moisture in the form of spray; in other ways it does not differ from saturated steam, having the same temperature at different pressures.

The percentage of dry steam in steam containing moisture, is called the quality of the steam. For example, if a pound of a given sample of steam contains 0.04 of a pound of water in the form of spray, and 0.96 of a pound of dry saturated steam, the quality is said to be 96



per cent. It is very important to know the quality of the steam when testing a boiler for capacity and fuel consumption, as water carried over in the form of spray has no value for the generation of power in a steam engine, or for heating purposes. As the quantity of steam evaporated in a given time is found by weighing the feed water, it is evident that the moisture contained in the steam will appear in the result, unless its percentage is known and the necessary correction made. The proportion of moisture in steam is found by means of a device called a calorimeter, which forms an important part of the equipment used in boiler testing.

The carrying over of moisture with the steam is commonly called *priming*. This may be caused by impure water, too high a water-line, the presence of oil, or of certain alkalis used in the removal of scale. Priming may also be caused by forcing a boiler beyond the capacity

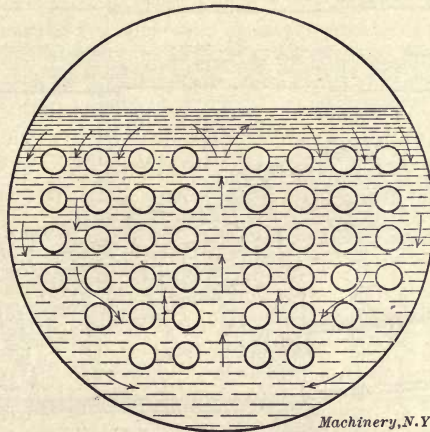

Fig. 1. Path of Currents in a Cylindrical Fire-tube Boiler

for which it is designed. When the steam rises from the surface of the water with too high a velocity, it has a tendency to carry more or less spray with it, which, when once in suspension, does not readily settle against a rising current, and thus passes over into the main with the steam.

A good circulation of the water in a boiler is necessary, not only for the best efficiency, but for durability and safety. Much more heat will be absorbed from the hot plates if the water passes over them at a fairly high velocity than if the movement is sluggish. Again, a good circulation reduces the formation of scale and prevents the plates from becoming overheated and burning. The direction of flow will depend upon the type of boiler and also upon the intensity of the fire. The general path of the currents in a cylindrical fire-tube boiler of the horizontal type, is indicated by the arrows in Fig. 1. The circulation in a water-tube boiler of the horizontal form with inclined tubes is shown in Fig. 2.

## Steam Tables

Steam tables, so called, may be found in many engineering hand-books, and in the catalogues of various kinds of steam apparatus.\* They give useful data relating to steam at different pressures, and the columns usually have the following headings:

1. Pressure.
2. Temperature.
3. Heat in water above 32 degrees.
4. Internal latent heat.
5. External latent heat.
6. Latent heat of evaporation.
7. Total heat of evaporation.
8. Weight of a cubic foot of steam, in pounds.
9. Volume of a pound of steam, in cubic feet.

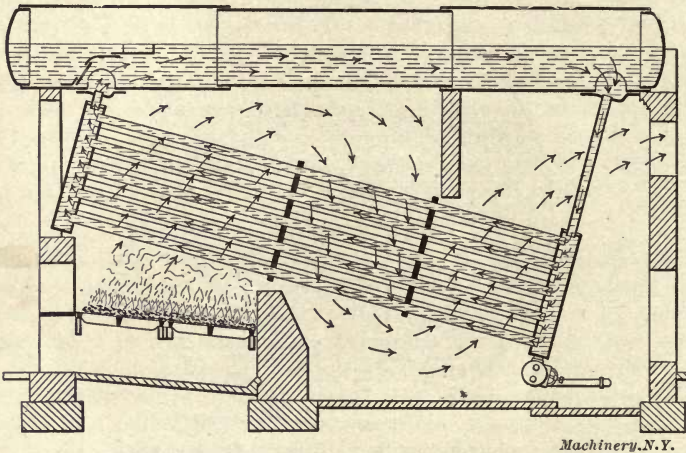

Fig. 2. Circulation of Water and Combustion Gases in a Water-tube Boiler

A condensed table of this type is given in the following; the values in this table are only approximate, but meet all practical requirements.

The pressure is sometimes given as absolute and sometimes as gage pressure; often both are given. In the first case the pressure is reckoned from zero, and does not take into account the atmospheric pressure. Gage pressure, on the other hand, means pressure above the atmosphere, and is approximately 15 pounds per square inch less than the absolute pressure. One can easily be changed to the other by adding or subtracting 15, as the case may be. Gage pressure is commonly understood, unless otherwise stated.

The second heading, in a table of properties of saturated steam, usually gives the temperature in degrees F., corresponding to the pressures in the first column. The third heading shows the heat units which

\*See MACHINERY'S Data Sheet Series No. 15, Heat and Steam, Steam and Gas Engines.

are required for raising the temperature of one pound of water from 32 degrees to the evaporating point under the given pressure. This value is practically the same as the number of degrees rise in temperature. The internal latent heat, usually given in the fourth column of a complete steam table, represents the heat required in the work of changing the water into steam, that is, in the process of evaporation. The fifth column gives external latent heat, or the heat expended in the work of expansion to the final volume also given in a complete steam table. The latent heat of evaporation, the sixth item, is the sum of the internal latent heat and the external latent heat. The seventh item, the total heat of evaporation includes the total heat required to raise 1 pound of water from a temperature of 32 degrees and evaporate it into steam at the given pressure. It is the sum of the corresponding quantities under the headings (3), (4), and (5). The data given under headings (8) and (9) are self-evident and need no ex-

TABLE I. PROPERTIES OF SATURATED STEAM

| Gage Pressure, Pounds per Sq. Inch | Temperature in Degrees F. | Heat in Water, above 32 degrees, in T. U. | Latent Heat of Evaporation, in T. U. | Total Heat of Evaporation, in T. U. |
|------------------------------------|---------------------------|---|--------------------------------------|-------------------------------------|
| 0                                  | 212                       | 181                                       | 966                                  | 1147                                |
| 10                                 | 240                       | 209                                       | 946                                  | 1155                                |
| 20                                 | 259                       | 228                                       | 933                                  | 1161                                |
| 30                                 | 274                       | 244                                       | 922                                  | 1166                                |
| 40                                 | 287                       | 257                                       | 912                                  | 1169                                |
| 50                                 | 298                       | 268                                       | 905                                  | 1173                                |
| 60                                 | 307                       | 278                                       | 898                                  | 1176                                |
| 70                                 | 316                       | 287                                       | 891                                  | 1178                                |
| 80                                 | 324                       | 295                                       | 886                                  | 1181                                |
| 90                                 | 331                       | 302                                       | 881                                  | 1183                                |
| 100                                | 338                       | 309                                       | 876                                  | 1185                                |

planation. The quantities given under the heads (3) to (7), inclusive, are in thermal units, and are for 1 pound of water or steam. Steam tables are used constantly in solving problems relating to steam engineering, and one should become familiar with them before attempting computations involving their use. In order to show their application, a few general examples will be solved, and with a view to facilitate matters, a portion of a steam table is given herewith for reference.

*Example 1.*—A storage tank contains a steam coil for heating water within it. How many pounds of steam at 30 pounds pressure, must be condensed in the coil to raise the temperature of 500 gallons of water, 100 degrees F.?

The weight of 500 gallons of water is  $500 \times 8.3 = 4150$  pounds. The heat required to raise this quantity 100 degrees in temperature, is  $4150 \times 100 = 415,000$  T. U. From Table I, the latent heat of evaporation for steam at 30 pounds pressure is 922 T. U. Hence,  $415,000 \div 922 = 450$  pounds of steam must be condensed to give out the required amount of heat.

*Example 2.*—If a pound of coal burned in the furnace of a boiler im-

parts 8000 T. U. to the water, how many pounds will be required to raise the temperature of 2000 pounds of water from 32 degrees F. and evaporate it into steam at 80 pounds pressure? How many pounds will be required to raise the water from a temperature of 50 degrees F. and evaporate it into steam at 100 pounds pressure?

In the first case the total heat of evaporation for steam at 80 pounds pressure (see Table I) is 1181; hence,  $2000 \times 1181 = 2,362,000$  T. U. are required. As 1 pound of coal gives 8000 T. U., then,  $2,362,000 \div 8000 = 295$  pounds are necessary.

In the second case, the temperature of steam at 100 pounds pressure is 338 degrees F.; therefore, the water must be raised  $338 - 50 = 288$  degrees F. before evaporation begins. This calls for approximately 288 T. U. for each pound of water. The latent heat of evaporation for steam at 100 pounds pressure is 876 T. U. Hence,  $288 + 876 = 1164$  T. U. must be given to each pound of water, or a total of  $1164 \times 2000 = 2,328,000$  T. U.; then,  $2,328,000 \div 8000 = 291$  pounds of coal are required.

#### Power of Boilers

Boilers are commonly rated in horsepower, although in power work the evaporation of a certain weight of water under stated conditions is sometimes called for instead. This, however, is practically the same thing expressed in a different way. The standard boiler horsepower in the United States is the capacity to evaporate 30 pounds of water per hour from a feed-water temperature of 100 degrees F. into dry steam at 70 pounds gage pressure. This is equivalent, as will be shown later, to the evaporation of 34.5 pounds of water from a temperature of 212 degrees into steam at atmospheric pressure, which corresponds to 0 pounds gage pressure.

It will be seen by reference to Table I that the total heat of evaporation varies for different pressures. It is also evident that the heat required to furnish a pound of steam will vary with the temperature of the feed water. This makes it necessary to have some standard when making a comparison of the capacity and efficiency of different boilers which are working under different conditions of feed-water temperature and steam pressure. The standard commonly employed is called the "equivalent evaporation from and at 212 degrees." This means, under any given condition, the equivalent evaporation from a feed-water temperature of 212 degrees F. into steam at atmospheric pressure.

*Example:*—A steam boiler is supplied with feed water at a temperature of 100 degrees F. and carries a pressure of 70 pounds gage. What is its equivalent evaporation from and at 212 degrees?

The quantity of heat required per pound of steam is found as follows: Temperature at 70 pounds pressure equals 316 degrees F. Heat required to raise the temperature from 100 to 316 degrees is  $316 - 100 = 216$  T. U. Latent heat of evaporation for 70 pounds pressure is 891 T. U. Therefore, the total heat required per pound of steam is  $216 + 891 = 1107$  T. U. The heat required to evaporate 1 pound of water from a temperature of 212 degrees F. into steam at the same temperature (0

gage pressure), is the latent heat of evaporation at this pressure, or 966 T. U. The ratio between 1107 and 966 is  $1107 \div 966 = 1.15$ , which is called the *factor of evaporation* for 100 degrees feed-water temperature and 70 pounds steam pressure. This means that 1.15 times as much heat is required per pound of steam under the first condition as under the second, or in other words, the equivalent evaporation from and at 212 degrees is  $30 \times 1.15 = 34.5$  pounds.

#### Factors of Evaporation.

The factors of evaporation for different combinations of feed-water temperature and steam pressure have been worked out and put in the form of a table for convenient use. (See Table II.)

*Example 1.*—A steam boiler carrying a pressure of 150 pounds per square inch, and supplied with feed water at a temperature of 60 degrees F., evaporates 300 pounds of water per hour. What is its equivalent evaporation from and at 212 degrees?

From Table II we find, for the given conditions of temperature and pressure, that the factor of evaporation is 1.207, which gives  $300 \times 1.207 = 362$  pounds as the equivalent evaporation from and at 212 degrees.

*Example 2.*—Two boilers of the same commercial rating are operated under different conditions of temperature and pressure, but are fired with the same grade of coal. Boiler No. 1 is supplied with feed water having an average temperature of 50 degrees F., and carries a steam pressure of 80 pounds per square inch. It evaporates 3000 pounds of dry steam per hour with a coal consumption of 515 pounds. Boiler No. 2 is used in connection with a heater and receives its feed water at a temperature of 200 degrees F. It carries a pressure of 140 pounds per square inch, and evaporates 3800 pounds of dry steam per hour with a coal consumption of 575 pounds. Which boiler is the most efficient—that is, which is evaporating the most dry steam per pound of coal?

Beginning with boiler No. 1, the first step is to find the evaporation from and at 212 degrees. The factor of evaporation is found from Table II to be 1.203, which gives an equivalent total of  $3000 \times 1.203 = 3609$  pounds of steam per hour, or  $3609 \div 515 = 7$  pounds of steam per pound of coal. In boiler No. 2 the factor of evaporation is 1.06, and the equivalent total evaporation  $3800 \times 1.06 = 4028$  pounds of steam per hour, which gives  $4028 \div 575 = 7$  pounds of steam per pound of coal, the same as in the case of boiler No. 1. Hence, the two boilers are giving practically the same efficiency, although working under different conditions.

#### Boiler Power for Different Purposes

The boiler power required for different purposes is usually found by reducing the steam consumption per hour to pounds from and at 212 degrees, and dividing the result by 34.5. In the following are given a number of methods for determining the weight of steam required for different purposes.

TABLE II. FACTORS OF EVAPORATION

| Feed Water Temperature, Deg. F. | Steam Pressure—Gage. |       |       |       |       |       |       |       |       |       |       |
|---------------------------------|----------------------|-------|-------|-------|-------|-------|-------|-------|-------|-------|-------|
|                                 | 50                   | 60    | 70    | 80    | 90    | 100   | 110   | 120   | 130   | 140   | 150   |
| 32                              | 1.214                | 1.217 | 1.219 | 1.222 | 1.224 | 1.227 | 1.229 | 1.231 | 1.233 | 1.234 | 1.236 |
| 35                              | 1.211                | 1.214 | 1.216 | 1.219 | 1.221 | 1.224 | 1.227 | 1.228 | 1.230 | 1.231 | 1.232 |
| 40                              | 1.206                | 1.209 | 1.211 | 1.214 | 1.216 | 1.219 | 1.220 | 1.223 | 1.224 | 1.226 | 1.228 |
| 45                              | 1.200                | 1.203 | 1.205 | 1.208 | 1.210 | 1.213 | 1.218 | 1.217 | 1.220 | 1.220 | 1.224 |
| 50                              | 1.195                | 1.198 | 1.200 | 1.203 | 1.205 | 1.208 | 1.210 | 1.212 | 1.214 | 1.215 | 1.217 |
| 55                              | 1.190                | 1.193 | 1.195 | 1.198 | 1.200 | 1.203 | 1.207 | 1.207 | 1.210 | 1.210 | 1.213 |
| 60                              | 1.185                | 1.188 | 1.190 | 1.193 | 1.195 | 1.198 | 1.200 | 1.202 | 1.204 | 1.205 | 1.207 |
| 65                              | 1.180                | 1.183 | 1.185 | 1.188 | 1.190 | 1.193 | 1.197 | 1.197 | 1.199 | 1.200 | 1.202 |
| 70                              | 1.175                | 1.178 | 1.180 | 1.183 | 1.185 | 1.188 | 1.190 | 1.192 | 1.193 | 1.195 | 1.196 |
| 75                              | 1.170                | 1.173 | 1.175 | 1.178 | 1.180 | 1.183 | 1.186 | 1.187 | 1.189 | 1.190 | 1.192 |
| 80                              | 1.164                | 1.167 | 1.169 | 1.172 | 1.174 | 1.177 | 1.179 | 1.181 | 1.183 | 1.184 | 1.186 |
| 85                              | 1.159                | 1.162 | 1.164 | 1.167 | 1.169 | 1.172 | 1.176 | 1.176 | 1.179 | 1.179 | 1.182 |
| 90                              | 1.154                | 1.157 | 1.159 | 1.162 | 1.164 | 1.167 | 1.169 | 1.171 | 1.172 | 1.174 | 1.175 |
| 95                              | 1.149                | 1.152 | 1.154 | 1.157 | 1.159 | 1.162 | 1.166 | 1.166 | 1.168 | 1.169 | 1.171 |
| 100                             | 1.144                | 1.147 | 1.149 | 1.152 | 1.154 | 1.157 | 1.159 | 1.161 | 1.162 | 1.164 | 1.165 |
| 105                             | 1.138                | 1.141 | 1.143 | 1.146 | 1.148 | 1.151 | 1.155 | 1.155 | 1.158 | 1.158 | 1.161 |
| 110                             | 1.133                | 1.136 | 1.138 | 1.141 | 1.143 | 1.146 | 1.148 | 1.150 | 1.152 | 1.153 | 1.155 |
| 115                             | 1.128                | 1.131 | 1.133 | 1.136 | 1.138 | 1.141 | 1.144 | 1.145 | 1.147 | 1.148 | 1.150 |
| 120                             | 1.123                | 1.126 | 1.128 | 1.131 | 1.133 | 1.136 | 1.138 | 1.140 | 1.142 | 1.143 | 1.145 |
| 125                             | 1.118                | 1.121 | 1.123 | 1.126 | 1.128 | 1.131 | 1.134 | 1.135 | 1.136 | 1.138 | 1.139 |
| 130                             | 1.112                | 1.115 | 1.117 | 1.120 | 1.122 | 1.125 | 1.128 | 1.129 | 1.131 | 1.132 | 1.134 |
| 135                             | 1.107                | 1.110 | 1.112 | 1.115 | 1.117 | 1.120 | 1.124 | 1.124 | 1.126 | 1.127 | 1.129 |
| 140                             | 1.102                | 1.105 | 1.107 | 1.110 | 1.112 | 1.115 | 1.117 | 1.119 | 1.121 | 1.122 | 1.124 |
| 145                             | 1.097                | 1.100 | 1.102 | 1.105 | 1.107 | 1.110 | 1.113 | 1.114 | 1.116 | 1.117 | 1.119 |
| 150                             | 1.092                | 1.095 | 1.097 | 1.100 | 1.102 | 1.105 | 1.107 | 1.109 | 1.111 | 1.112 | 1.114 |
| 155                             | 1.086                | 1.089 | 1.091 | 1.094 | 1.096 | 1.099 | 1.103 | 1.103 | 1.105 | 1.106 | 1.108 |
| 160                             | 1.081                | 1.084 | 1.086 | 1.089 | 1.091 | 1.094 | 1.097 | 1.098 | 1.100 | 1.101 | 1.103 |
| 165                             | 1.076                | 1.079 | 1.081 | 1.084 | 1.086 | 1.089 | 1.093 | 1.093 | 1.095 | 1.096 | 1.098 |
| 170                             | 1.071                | 1.074 | 1.076 | 1.079 | 1.081 | 1.084 | 1.086 | 1.088 | 1.089 | 1.091 | 1.093 |
| 175                             | 1.066                | 1.069 | 1.071 | 1.074 | 1.076 | 1.079 | 1.082 | 1.083 | 1.085 | 1.086 | 1.088 |
| 180                             | 1.060                | 1.063 | 1.065 | 1.068 | 1.070 | 1.073 | 1.076 | 1.077 | 1.079 | 1.080 | 1.082 |
| 185                             | 1.055                | 1.058 | 1.060 | 1.063 | 1.065 | 1.068 | 1.072 | 1.072 | 1.074 | 1.075 | 1.077 |
| 190                             | 1.050                | 1.053 | 1.055 | 1.058 | 1.060 | 1.063 | 1.066 | 1.067 | 1.069 | 1.070 | 1.072 |
| 195                             | 1.045                | 1.048 | 1.050 | 1.053 | 1.055 | 1.058 | 1.062 | 1.062 | 1.064 | 1.065 | 1.067 |
| 200                             | 1.040                | 1.043 | 1.045 | 1.048 | 1.050 | 1.053 | 1.055 | 1.057 | 1.058 | 1.060 | 1.061 |

*Steam Engines.*—Table III gives the average steam consumption in pounds per indicated horsepower per hour, for engines of different types. The values given, however, will vary somewhat, depending upon the size, pressure, and cut-off; but in the absence of more definite information, they may be used to obtain approximate results.

*Example:*—What boiler horsepower will be required to supply a medium-speed non-condensing simple engine, operating under a boiler pressure of 80 pounds per square inch and rated at 100 indicated horsepower? The temperature of the feed water is 60 degrees F.

The average steam consumption for an engine of this type, as found from Table III, is 30 pounds per indicated horsepower (I. H. P.),

TABLE III. STEAM CONSUMPTION OF ENGINES

| Kind of Engine | Pounds of Steam per Indicated Horsepower per Hour |            |
|----------------|---|------------|
|                | Non-condensing                                    | Condensing |
| Simple {       | High-speed  | 24         |
|                | Medium-speed                                      | 23         |
|                | Corliss   | 22         |
| Compound {     | High-speed*                                       | 20         |
|                | Medium-speed                                      | 19         |
|                | Corliss   | 18         |

which gives a total of  $100 \times 30 = 3000$  pounds of steam per hour. Reducing this to an equivalent evaporation from and at 212 degrees, and dividing by 34.5, we have:

$$\frac{3000 \times 1193}{34.5} = 104 \text{ boiler horsepower required.}$$

*Steam Pumps.*—The boiler power for operating duplex steam pumps is found in a manner similar to that described for steam engines, by using the quantities given in Table IV, which are the pounds of steam per hour per *delivered* horsepower.

TABLE IV. STEAM CONSUMPTION OF DUPLEX PUMPS (NON-CONDENSING)

| Kind of Pump          | Pounds of Steam per Delivered Horsepower per Hour |
|-----------------------|---|
| Simple .....          | 130   |
| Compound .....        | 70  |
| Triple Expansion..... | 40  |
| High Duty.....        | 30  |

*Electric Generators.*—The indicated horsepower of an engine for driving an electric generator may be found by multiplying the kilowatt (K. W.) rating of the generator by 1.7, after which the boiler power may be found in the manner already described for steam engines, depending upon the type of engine used.

*Refrigeration.*—In computing the power required for refrigeration it is customary to allow 1.5 indicated horsepower at the steam cylinder of the compressor for each ton of refrigeration. From this the boiler

power can be determined as already described. In the actual manufacture of ice, twice the power is required as compared with that for "ice-melting effect" or "refrigeration."

*Heating.*—The boiler power for steam heating depends upon the type of radiation to be supplied. Under average conditions 1 square foot of radiating surface will condense the weight of steam per hour given in Table V, which is for low pressure heating at about 5 pounds per square inch.

TABLE V. CONDENSATION FOR DIFFERENT TYPES OF RADIATION

| Type of Radiating Surface | Pounds of Steam Condensed per Hour<br>per Square Foot of Radiation |
|---------------------------|--|
| Direct radiators .....    | 0.3  |
| Indirect radiators .....  | 0.6  |
| Steam-blast coils .....   | 1.8  |

As the condensation is usually returned to the boiler at a high temperature, the conditions attending low-pressure heating approximate those of evaporation from and at 212 degrees. For this reason, it is usually sufficiently accurate to divide the weight of steam required per hour by 34 to find the boiler horsepower, without corrections for temperature and pressure as in high-pressure work.

*Example:*—A building contains 5000 square feet of direct radiation; 2000 square feet of indirect radiation; and 3000 square feet of steam-blast coils. What boiler power will be required for low pressure heating?

The answer is found as follows:

$$5000 \times 0.3 = 1500$$

$$2000 \times 0.6 = 1200$$

$$3000 \times 1.8 = 5400$$

Total steam per hour = 8100 pounds; hence,  $8100 \div 34 = 238$  boiler horsepower is required.



## CHAPTER II

### GENERAL PROPORTIONS OF BOILERS

There are certain general proportions which are common to all boilers, and these will be discussed briefly before taking up the different types in detail. A general description of different types of boilers will then follow in the next chapter, and subsequently, the design of the most common form of boiler will be treated.

#### Heating Surface

The heating surface of a boiler is commonly defined as that portion having one side of the plates or tubes exposed to the hot gases and the other in contact with the water. There is some question as to which side of the plates should be considered when computing the heating surface, but it is more common to take the fire surface rather than the water surface. The capacity of a boiler depends not only upon the amount of heating surface, but on its arrangement as well. In order to give the best efficiency, it must be so located as to produce a good distribution of the gases and to absorb as much of their heat as possible without injuring the draft. The best results are secured when the gases pass over the heating surfaces in such a direction that the hottest gas will be on the side of the plate opposite the hottest part of the circulating water. This result is secured in the arrangement shown in Fig. 2.

In the case of horizontal tubular boilers, of the fire-tube type, it is customary in calculating the heating surface, to take the sum of one-half the shell, two-thirds the rear head less the tube area, and the interior surface of all the tubes. The front head is not counted as heating surface, because the gases have become considerably cooled by the time they reach this point, and also because the direction of flow is away from the head instead of toward it.

The rating of a boiler is based on the amount of heating surface which it contains. In the case of horizontal fire-tube boilers of good design, it is customary to allow 12 square feet of heating surface per rated horsepower for power boilers of good size, and about 15 square feet for heating boilers. The distinction between power and heating boilers depends simply upon the size of the boiler and the care which it receives as regards clean heating surfaces and skill in firing. Power boilers usually receive better care in both these directions, and are therefore given a somewhat higher rating for a given amount of heating surface. Water-tube boilers are rated on a basis of 10 square feet of heating surface per horsepower, because a large proportion of the surface is more directly exposed to the fire and hot gases, and also because the circulation of water is more rapid through the tubes.

The weight of coal burned per square foot of grate surface per hour is called the rate of combustion. This commonly varies from 12 to 18 pounds in the case of power plants operating under natural draft, running up to 30 pounds or more when forced draft is employed. With heating boilers, the combustion is somewhat less, it not being usual to force the boilers so much, except in large plants. Here the rate drops to 8 or 10 pounds in boilers of medium size, and to 6 or 7 in those of small size, depending upon the care which they receive and the strength of chimney draft.

The weight of dry steam evaporated per pound of coal is called the rate of evaporation. This varies with the character of the heating surface and its relation to the grate area. In power boilers of good design, the rate of evaporation commonly runs from 9 to 10 pounds, while in the case of heating boilers, 7 to 8 pounds is more common.

#### Grate Area

The proper relation between the heating surface and the grate area depends largely upon the chimney draft, the kind of fuel used, and also upon the type of boiler and the arrangement of the heating surface. The grate area in any particular case may be computed by the following rule, when the probable rates of combustion and evaporation are known:

Multiply the horsepower of the boiler by 34.5, and divide the result by the product of the rate of combustion times the rate of evaporation. The final result will be the required grate area in square feet.

*Example 1.*—What should be the grate area for a 100 horsepower boiler in a power plant operating under favorable conditions with natural draft?

Assuming the rates of combustion and evaporation to be 15 and 10 pounds, respectively, and applying the rule given, we have:

$$\frac{100 \times 34.5}{15 \times 10} = 23 \text{ square feet.}$$

*Example 2.*—What grate area should be provided for a 40 horsepower heating boiler, working under average conditions?

Assuming the rates of combustion and evaporation to be 10 and 8 pounds, respectively, we have:

$$\frac{40 \times 34.5}{10 \times 8} = 17 \text{ square feet.}$$

The ratio of the heating surface to the grate area, in the case of power boilers, is commonly made from 30 to 40 for anthracite, and from 40 to 50 for bituminous coal. Taking a water-tube boiler rated on a basis of 10 square feet of heating surface per horsepower, and assuming a ratio of 40, the grate area is found to be  $10 \div 40 = 0.25$  square feet per horsepower. This corresponds very closely to the area computed by the rule for a rate of combustion of 14 pounds and an evaporation of 10 pounds. In like manner, a ratio of 50 corresponds to a combustion of 17 pounds, and an evaporation of 10 pounds.

## Proportions of Steam and Water Space

The steam space must have sufficient volume to act as a storage reservoir so that moisture which may be carried up with the bubbles of steam may have a chance to fall back. A sufficient volume is also necessary in order that the intermittent draft of steam made by the engine will not cause a fluctuation of the steam pressure or water line. There are various methods of determining the volume of the steam space. A safe rule in rather common use, is to provide a space equal to the volume of steam used in 20 seconds. The volume of steam required in 20 seconds may be found by the following rule:

Multiply the rated horsepower of the boiler by 34.5, then divide this product by the product of 180 times the factor of evaporation for the conditions under which the boiler is to operate. The quotient multiplied by the volume of 1 pound of steam, in cubic feet, at the required boiler pressure, will give the necessary steam space in cubic feet.

*Example:*—Find the steam space for an 80 horsepower boiler carrying 100 pounds pressure per square inch, and having a feed-water temperature of 50 degrees F.

The necessary data for applying the above rule are as follows:

Horsepower of boiler = 80.

Factor of evaporation for stated conditions = 1.2.

Volume of 1 pound of steam at 100 pounds pressure = 3.8 cubic feet.

$$\frac{80 \times 34.5}{1.2 \times 180} \times 3.8 = 49 \text{ cubic feet.}$$

A common method employed, in the case of horizontal tubular boilers, is to carry the water line a distance equal to about 1/3 the diameter from the top of the shell. This, however, should be checked for volume and for water surface, the first by the rule just given, and the second by the method given below:

In horizontal tubular boilers the velocity with which the steam leaves the surface of the water should not exceed about 2.5 feet per minute. Hence, the volume of steam, in cubic feet, generated per minute, divided by 2.5, will give the required surface at the water line. The volume of steam generated per minute may be found by multiplying the steam space, as computed by the rule previously given, by 3. Hence in the preceding example, the water surface should be:

$$\frac{49 \times 3}{2.5} = 59 \text{ square feet.}$$

An 80 horsepower boiler of usual proportions has a shell 66 inches in diameter and 16 feet in length. If the water line is carried 1/3 of the diameter from the top of the shell, it will give a steam space of approximately 100 cubic feet, and a water surface of 80 square feet, both of which are well on the side of safety.

A boiler should have sufficient water capacity to furnish a reservoir for supplying suddenly increased demands for steam without drawing the water line below a safe point or cutting down the pressure.

## CHAPTER III

### CLASSIFICATION AND TYPES OF BOILERS

Boilers are commonly divided into two classes, externally fired and internally fired. In the former class the furnace is outside the boiler (see Figs. 10 and 40), and in the latter, the grate is inside the boiler proper (see Figs. 4 and 5). These general divisions are subdivided according to certain details of construction, the most common in stationary plants being the *fire-tube* and *water-tube* boilers.

Externally fired boilers usually require a brick setting, which is a matter of considerable expense, but on the other hand, the structure of the boiler is less complicated, and, hence, less subject to repairs. The various forms of water-tube boilers in common use are externally fired. The internally fired boiler is more economical in the use of fuel, because all heat radiated from the furnace is absorbed by the water which surrounds it. The expense of a brick setting is also avoided. Internally fired boilers are more commonly used in marine and railway practice than in stationary work, although several boilers of this class are designed especially for power and heating purposes.

#### Fire-tube Boilers

Boilers of the fire-tube type are so designed that the hot gases pass through the tubes which are enclosed in a shell and surrounded with water. The horizontal return tubular boiler is the most common form of fire-tube boiler, although the vertical form is sometimes used where floor space is limited. Certain makes of internally fired boilers are also constructed with fire tubes, as are also the usual types of marine and locomotive boilers.

The horizontal tubular boiler is extensively used for heating, and to a considerable extent for power work. Some of the advantages claimed for this type of boiler are its low first cost, large water capacity, and its simplicity of construction.

#### Water-tube Boilers

In the case of water-tube boilers, the construction is the reverse of the fire-tube boiler, that is, the water is inside the tubes, which are surrounded by the hot gases. This gives a more rapid circulation to the water, which increases the efficiency of the heating surface. In addition to this, the large amount of surface exposed directly to the fire increases the transmission of heat and prevents overheating. The draft area, which is sometimes constricted in fire-tube boilers, is always ample in this form, which gives a slower movement to the gases and allows more time for the absorption of their heat by the water. Other advantages are the rapidity with which steam may be raised, owing to the water being divided into a large number of small streams

which pass through the hottest part of the fire, and also the safety due to the same cause, the division of the water into small masses preventing serious results in case of rupture.

Water-tube boilers represent the latest development in this field, especially for power work, as fire-tube boilers are seldom used for pressures as high as 150 pounds per square inch. They are made both horizontal and vertical in form, the tubes in the former being inclined upward toward the front in order to assist in the circulation. The whole arrangement is surrounded with a brick setting, the weight being carried by a steel structure built into the brickwork. When properly constructed, the different surfaces are easily reached for cleaning, and being made up of comparatively small parts, are easily transported and erected. The principal disadvantage is the small amount of water space, which limits the reserve capacity in case of sudden calls for steam.

#### Types of Boilers

In the following, brief descriptions will be given of a number of representative types of both fire-tube and water-tube boilers. There

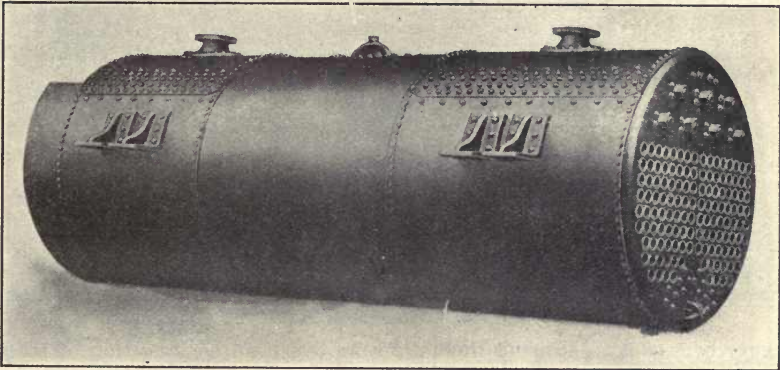

Fig. 3. Horizontal Tubular Boiler

are many similar forms in common use, those shown being chosen simply because they illustrate certain details of construction which it is desired to bring out.

#### Horizontal Tubular Boilers

An external view of a horizontal tubular boiler is shown in Fig. 3. It consists of a steel or wrought iron shell made up with riveted joints, with a large number of fire tubes expanded into the heads. The lower portion of each head is supported against internal pressure by the tubes, while that portion above the tubes is provided with special stays or braces, as shown. Access to the interior is by means of a man-hole in the top of the shell above the tubes, and hand-holes in the heads. Sometimes the hand-holes are replaced by man-holes, a sufficient number of tubes being omitted to give the required space. This is a very good arrangement as that portion of the boiler below the tubes is subject to the accumulation of sediment and scale and

should be readily accessible for cleaning. When a man-hole is provided only in the top, it is very difficult, if not impossible, to thoroughly inspect the lower portion of the boiler. The shell is provided with two nozzles on top, one for the steam connection and one for the safety valve. The nozzles are shown in the illustration and are usually made of steel castings or gun metal, although forged steel nozzles are often employed in the best class of high-pressure work.

Heating boilers, and power boilers of small and medium size, are commonly supported by cast-iron lugs riveted to the shell which rest on the brickwork of the setting. A better arrangement for high-pres-

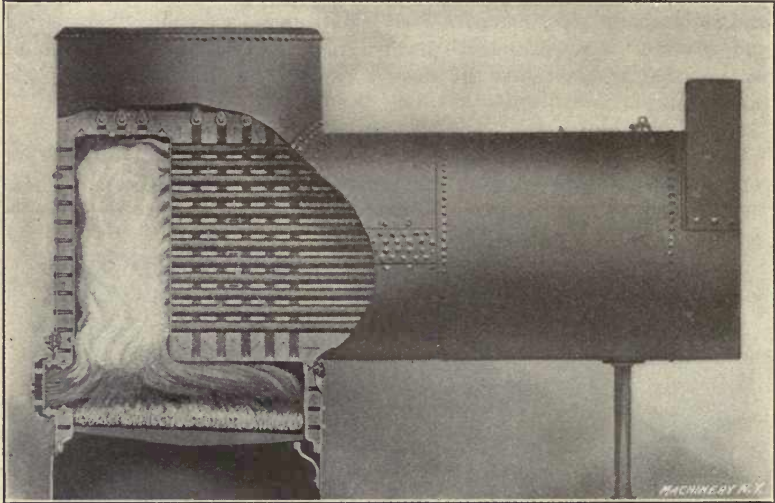

Fig. 4. Fitzgibbons Boiler

sure boilers is to suspend them from an overhead construction of steel girders, thus relieving the brickwork of all load except its own weight.

#### Fitzgibbons Boiler

The Fitzgibbons boiler, shown in Fig. 4, is an internally fired boiler of the fire-tube type. It has a large combustion chamber directly over the furnace so arranged that the burning gases are brought back toward the firing door before entering the tubes. This allows the introduction of sufficient air to produce a more complete combustion than would otherwise be the case. Another advantage of this arrangement lies in the location of the combustion chamber, which is such as to bring the burning gases at a high temperature within a short distance of the water level in the boiler, thus producing a rapid generation of steam at this point. The tube barrel is entirely submerged, and as the water becomes heated and rises to the vertical portion, its place is filled by currents from the water-leg surrounding the furnace, thus producing a rapid circulation over the heating surfaces.

As regards construction, the tube shell is flanged and riveted to the vertical shell, the opening in the latter being cross-braced to give it

the strength of a complete cylinder. In addition to this, the vertical shell is stayed to the furnace and to the combustion chamber. This form of boiler requires no brick setting—simply a covering of some good form of plastic or block insulation.

#### Robb-Mumford Fire-tube Boiler

In Fig. 5 is shown the Robb-Mumford fire-tube boiler. This boiler has an inclined corrugated furnace of cylindrical form, connected at the rear end to a number of tubes, as shown. The furnace and tubes are surrounded by a cylindrical shell connected at the front and rear with the steam and water drum above. The circulation of water through the boiler is indicated by the arrows, being downward through the front and upward through the rear connection. The gases, after passing over the bridge wall at the back of the grate, enter the

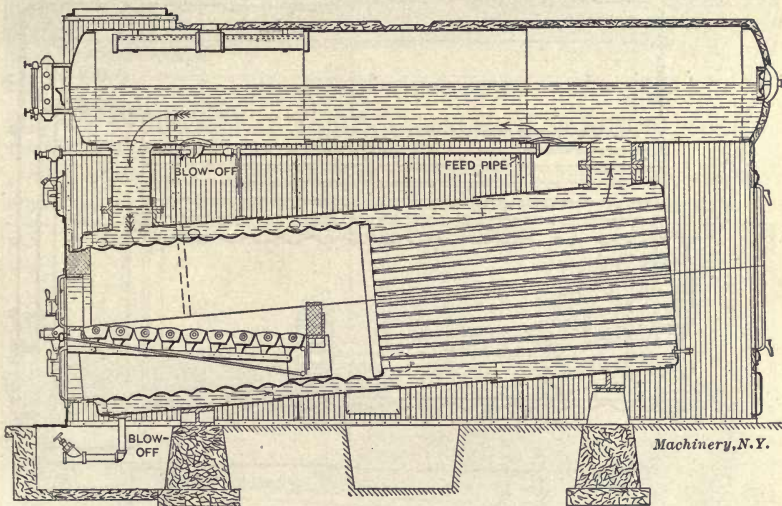

Fig. 5. Robb-Mumford Fire-tube Boiler

tubes, and passing through these, are returned to the front by way of the enclosed space surrounding the lower cylinder, and are taken off at the front on top.

The casing connecting the upper and lower shells is constructed of steel plate on an angle-iron frame, and lined with asbestos air-cell blocks to prevent the radiation of heat. The same form of covering is also used on top of the steam drum and on the bottom of the lower shell. With the exception of the tube sheets, all parts of the boiler, subjected to the pressure, are cylindrical or spherical in form, so that no stays are required, the heads being supported by the tubes.

#### Marine Fire-tube Boilers

A typical form of marine boiler is shown in Fig. 6. This boiler has an internal corrugated furnace of cylindrical form connecting with a combustion chamber at the rear. From here the gases enter the

tubes which connect with the smoke bonnet or uptake at the front. The heads above the tubes are supported by through braces in a similar manner to that employed for return tubular boilers. This form of boiler is compact and self-contained, and therefore well adapted to marine work, for which it is extensively used.

#### Heine Water-tube Boiler

The Heine water-tube boiler is shown in Fig. 7, without its brick setting. It consists of a steam and water drum at the top connected with a water-leg at each end, into which are expanded a large number of tubes as shown. The water-legs are nearly rectangular in form, being drawn in at the top to fit the curvature of the shell. They are stiffened by hollow stay-bolts of large size so placed that two stays

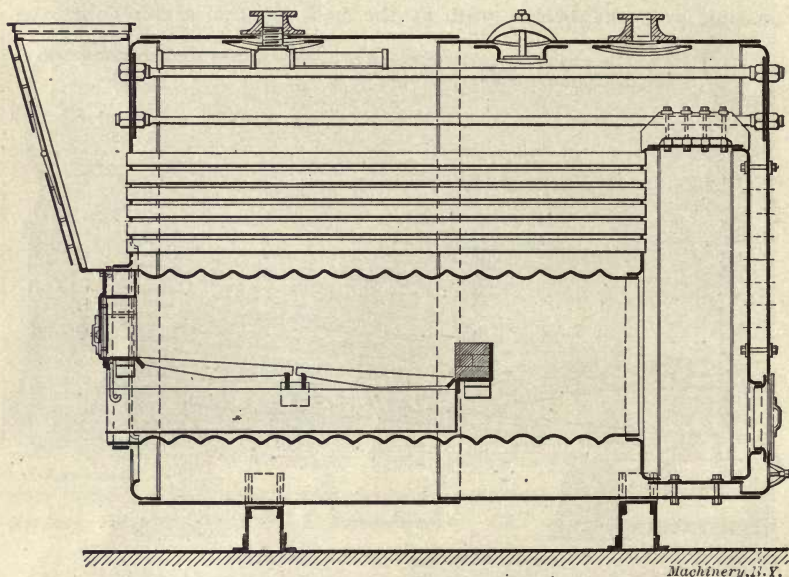

Fig. 6. Typical Form of Marine Fire-tube Boiler

support each tube and hand-hole. Access to the tubes is through the hand-holes, one being placed over the end of each, in the outer faces of the water-legs. The drum is cylindrical in form, with dished heads which require no staying. The main steam outlet is on top of the drum near the front end (at the right in the illustration). The standard tee, which is attached at this point, has two outlets, one being used for the main steam connection and the other for the safety valve.

#### Franklin Water-tube Boiler

The Franklin water-tube boiler, Fig. 8, is similar in construction to the one just described, and is shown with its brick setting. The boiler is set in an inclined position in order to assist in the circulation through the tubes. The path of the gases is plainly shown in the illustration; they first pass over the bridge wall, then upward among



the tubes, and forward to an opening at the front, and then backward again under the main drum to the smoke uptake at the rear. Two deflecting walls of tile laid on the tubes serve to make the gases take

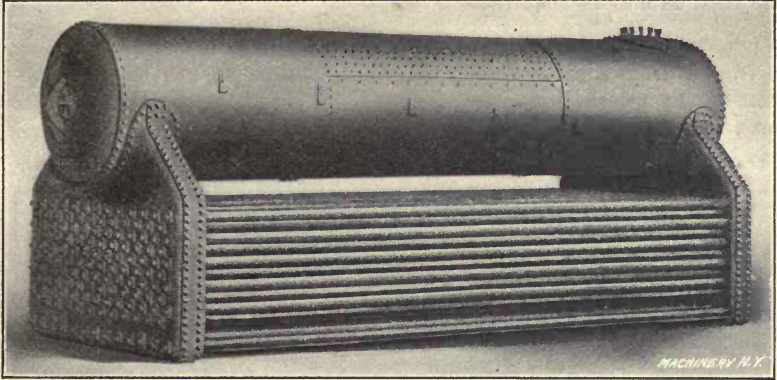

Fig. 7. Heine Water-tube Boiler

this course, this causing a large proportion of their heat to be absorbed by the water within the boiler.

The steam outlet is at the front of the main drum on top, and dry steam is insured by the use of a dry pipe and deflecting plate directly

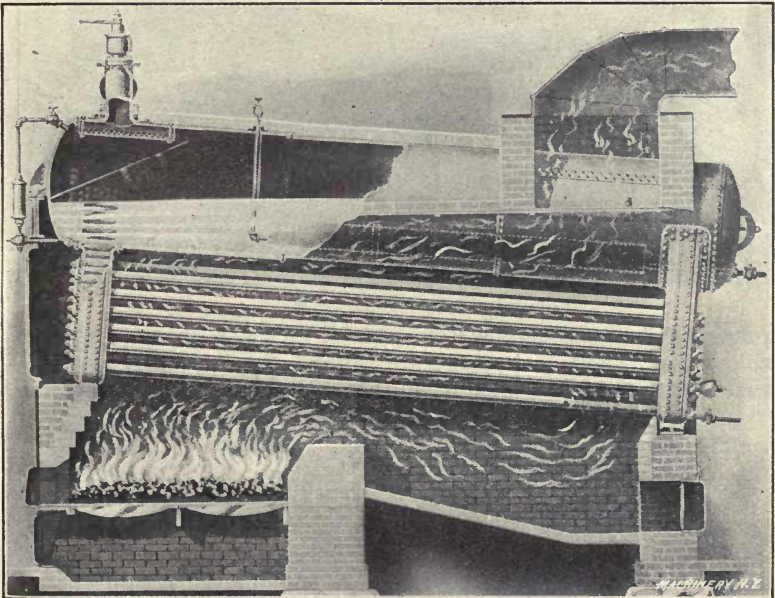

Fig. 8. Franklin Water-tube Boiler

below it which prevents spray from being carried over with the steam, even when the boiler is being forced. The water column connection is made with the front of the main drum, and a mud drum of thin

steel occupies the position shown partly by dotted lines. The feed water is discharged into this, where it is heated and deposits its impurities, which may be blown off from time to time through a pipe at the rear, as may be required.

#### Keeler Water-tube Boiler

The Keeler water-tube boiler, Fig. 9, is similar in general construction to the boilers just described. The gases of combustion in this case, however, take a somewhat different course than in the Heine and Franklin boilers, being deflected upward and downward, alternately,

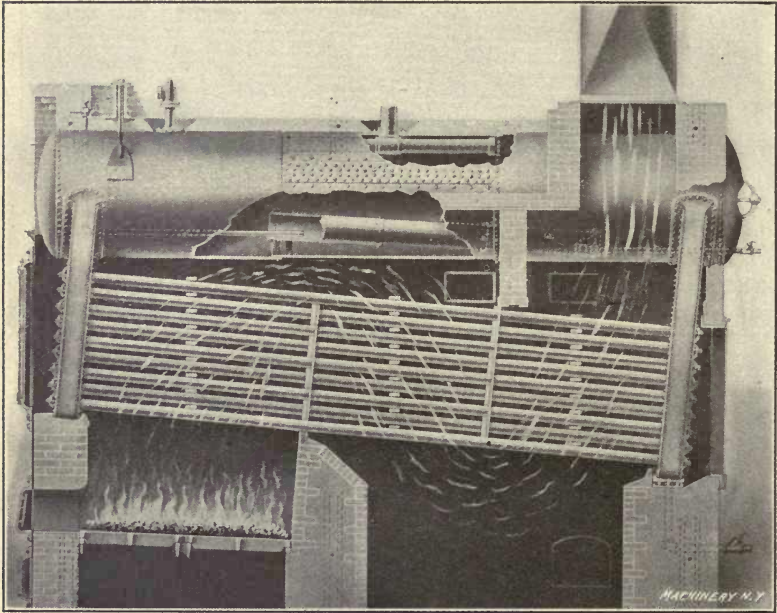

Fig. 9. Keeler Water-tube Boiler

by special vertical baffle plates, as shown. When bituminous coal or lignite is used, horizontal baffles are better, so that the large amount of gas distilled may be supplied with heat from the tile lining of the furnace, and ignited to complete combustion before coming in contact with the tubes.

The tubes are either  $3\frac{1}{2}$  or 4 inches in diameter and 16 or 18 feet in length. They are set in zigzag vertical, and in straight horizontal, rows, 6 inches between centers. There is a hand-hole opposite each tube, of such size that the tube may be easily replaced without disturbing the rest of the boiler in any way. A dry pipe and mud drum are provided, similar to those in the boiler in Fig. 8. In this case, however, the steam outlet is at the center of the main drum instead of at the end. The units commonly vary from 75 to 300 horsepower, the larger sizes having two drums.

## Babcock and Wilcox Water-tube Boiler

In Fig. 10 is shown the Babcock and Wilcox water-tube boiler. This boiler is employed both for land and marine work, although certain changes in construction are necessary when it is used for the latter purpose, in order to give it more compactness. The various designs, however, embody the same general principles of construction, which are indicated in the illustration. The tubes are inclined as shown, and connected with headers at both ends, which in turn connect with the steam and water drum at the top. The rear header also connects with a mud drum or settling chamber, provided with a blow-off pipe and cock. Openings are left in the headers opposite the tube ends for use in cleaning or for renewal, and are closed by hand-hole plates of special design. Steam is taken from the top of the main drum near the rear, a dry-pipe being provided as shown.

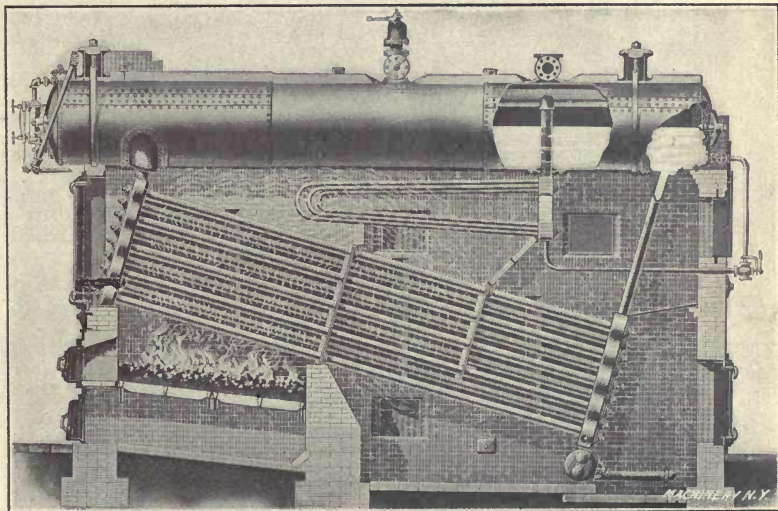

Fig. 10. Babcock and Wilcox Water-tube Boiler

An interesting feature shown in this illustration is the superheater, consisting of a series of coils connecting with the dry pipe, and exposed directly to the hot gases of the furnace. The office of this device is to heat the steam to a temperature higher than that due to its pressure, as already described in Chapter I.

## National Water-tube Boiler

The National water-tube boiler, shown in Fig. 11, is similar in general design to the one just described. One of its special features is the construction of the headers for strength, and the provision made for expansion. Each header contains two tubes in height and three in width, all being expanded into bored holes and assembled in groups of three to six headers, placed one above the other. The general path of the gases is clearly shown in the illustration.

## Goss Water-tube Boiler

In Fig. 13 is shown the Goss water-tube boiler. This boiler is made in sizes from 100 to 500 horsepower, and for steam pressures from 150

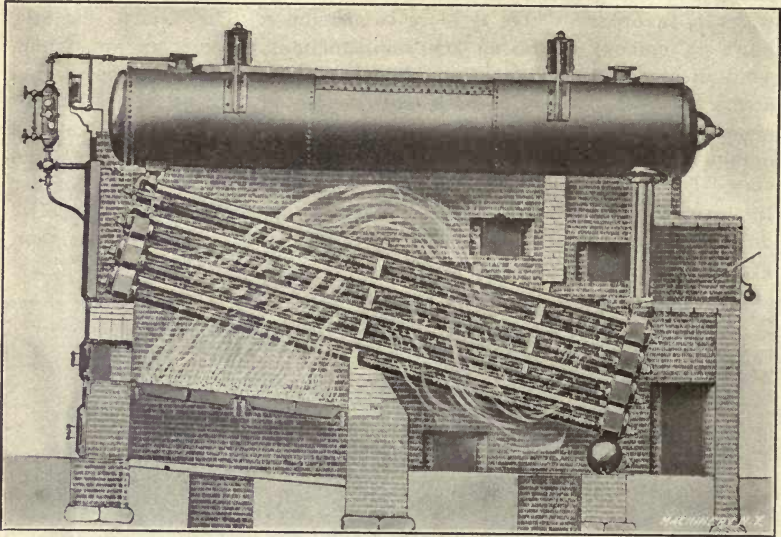

Fig. 11. National Water-tube Boiler

to 250 pounds per square inch. The main heating surface consists of a cylindrical nest of tubes with headers at each end, which are con-

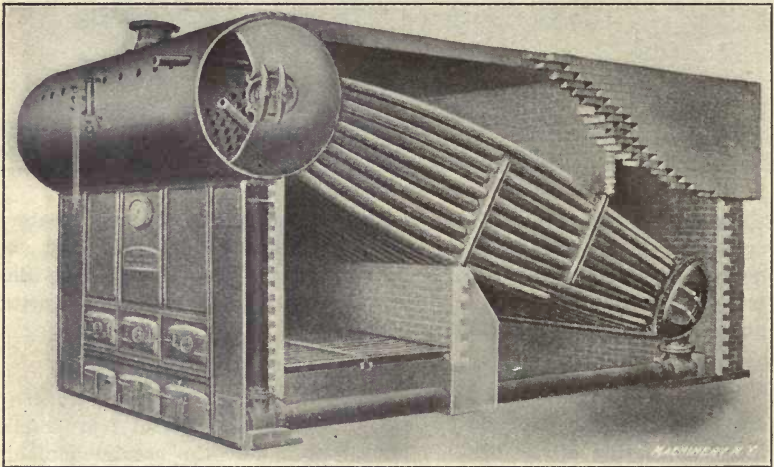

Fig. 12. Mosher Water-tube Boiler

nected with the main steam and water drum by vertical pipes of large size. One of the features of this boiler is the arched furnace of fire-brick, so constructed as to form a heat reservoir in which the tempera-

ture can be maintained at a point where the gases from the volatile matter will be ignited after thoroughly mixing with the inflowing air.

#### Mosher Water-tube Boiler

In Fig. 12 is shown the Mosher water-tube boiler. This boiler consists of four principal parts, the steam drum, the water drum, the tubes, and the return pipes, the relative location of which are shown in the illustration. The horizontal portions of the return pipes, which pass through the ash pit, act as mud drums, and are provided with cleanout openings at each end. The expansion of the tubes is cared for by curving them slightly, as shown. The gases are deflected upward and downward among the tubes by the use of vertical baffle

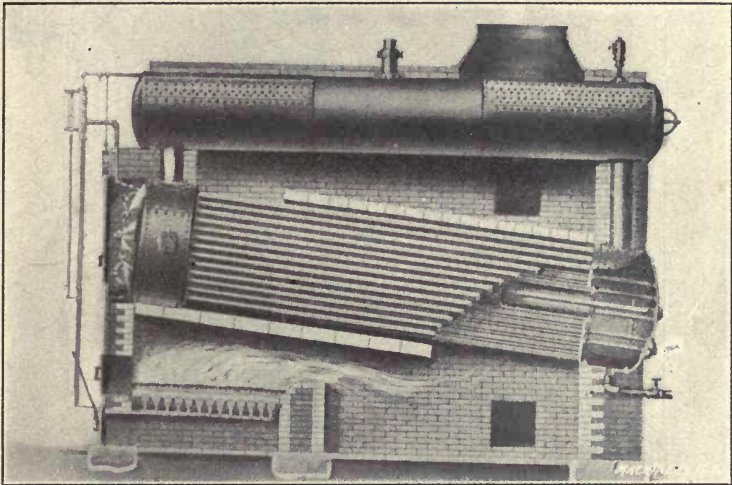

Fig. 13. Goss Water-tube Boiler

plates. The circulation of the water is from the rear drum to the steam drum, through the tubes, then downward and back to the rear drum by way of the large return pipes at each side near the floor.

#### Stirling Water-tube Boiler

The Stirling water-tube boiler, Fig. 14, is somewhat different in construction to any of the boilers which have been so far described. It consists of three upper or steam drums, and one lower or mud drum, connected by tubes as shown. The gases of combustion are directed over the banks of tubes by baffles of fire-tile laid against the tubes, as indicated by the shaded portions. The boiler is supported on a structural steel framework, around which is built a brick setting to enclose the furnace and confine the gases in the proper channels. The feed water enters the rear top drum, flows downward through the tubes to the mud drum, then upward through the front bank of tubes directly over the furnace, across to the middle drum, and downward to the mud drum again. The steam is taken from the middle drum as shown

by the nozzle on top. The furnace has a fire-brick arch over the grates just back of the fire door. This arch absorbs heat from the fire and becomes an incandescent radiating surface which assists in the combustion of the gases given off when coal is first fired.

#### Worthington Water-tube Boiler

The Worthington water-tube boiler, Fig. 15, is a sectional boiler very compact in form and having a large proportion of its heating surface directly over the fire. The furnace is constructed of brick, and also serves as a support for the boiler, as shown. The tubes and lower por-

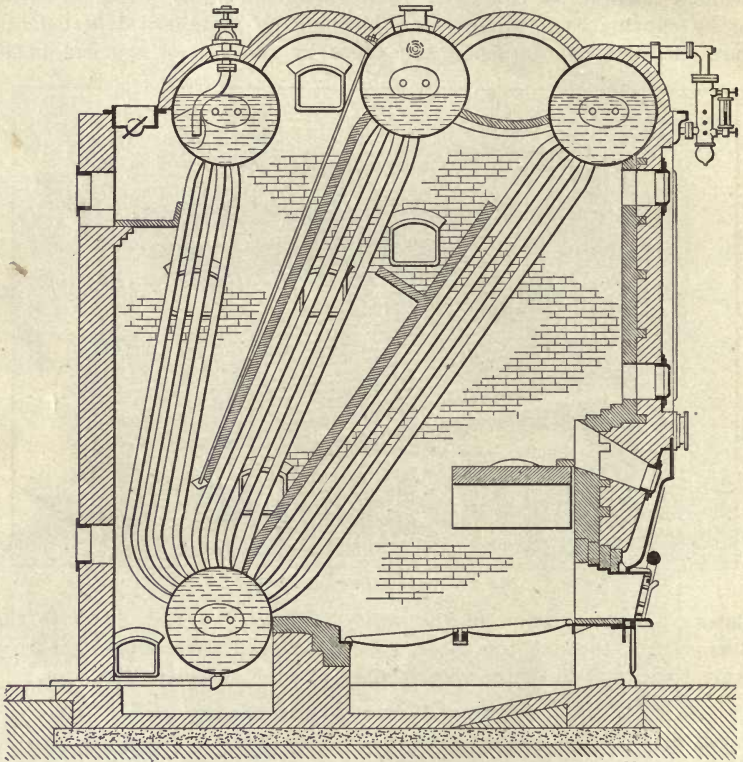

Fig. 14. Stirling Water-tube Boiler

*Machinery, N.Y.*

tion of the steam drum are enclosed in a casing of iron plate lined with asbestos air-cells, to prevent the radiation of heat. Being made in sections, the boiler can be installed in places which are inaccessible to many other forms. A 200 horsepower boiler is easily passed through a 4 by 4-foot opening. By certain changes in the setting, it can be made either end fired or side fired, as most desirable.

#### Manning Boiler

In Fig. 16 is shown the Manning boiler. This is a fire-tube boiler of the vertical type, especially adapted to places where the floor space

is limited and large power installations are required. An interesting feature in the design of this boiler is the provision made for the expansion of the tubes and the shell. This is cared for by the use of a double flanged head connecting the barrel or cylindrical part of the boiler with the outside of the firebox, which forms an expansion joint, and at the same time gives a larger firebox. This design produces especially dry steam, on account of the water level being so far below the

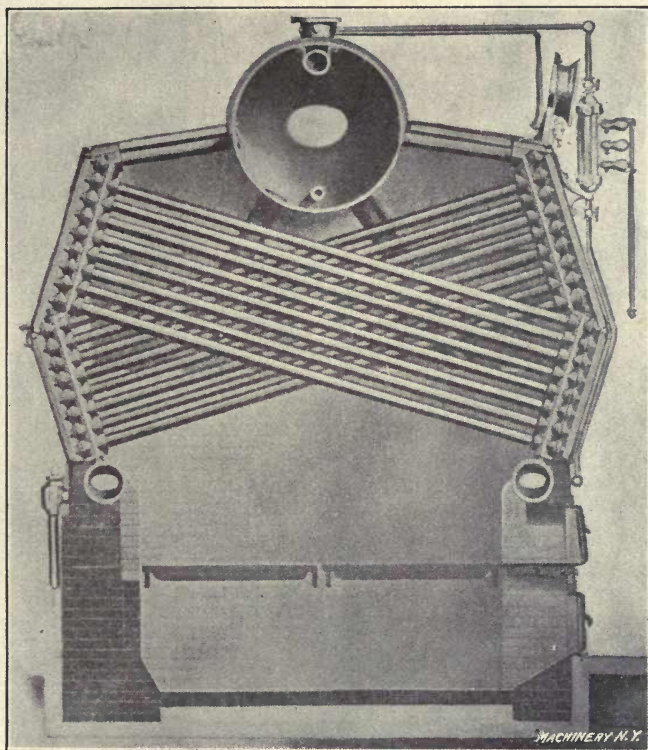

Fig. 15. Worthington Water-tube Boiler

upper tube sheet, thus allowing the highly heated tubes to pass through the steam space as shown.

#### Wickes Water-tube Boiler

The Wickes water-tube boiler, Fig. 17, is somewhat similar in form to the preceding one, except it is of the water-tube type and requires a brick setting. The boiler consists of two cylinders or drums joined together by straight tubes which are divided into two sections by a fire-brick partition. The furnace is constructed of brick-work and projects in front of the boiler as shown. The gases pass upward among the tubes in front of the tile partition, then downward at the back, and enter the smoke flue near the bottom. The circulation of water is up-

ward through the tubes at the front, which are exposed to the hottest portion of the fire, and downward through the tubes at the rear of the partition.

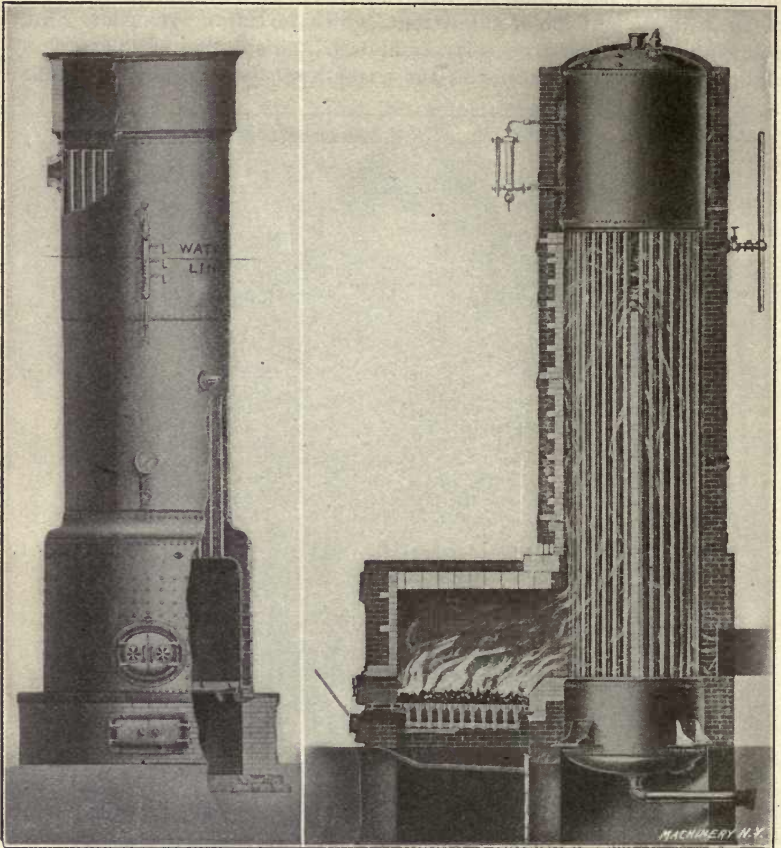

Fig. 16. The Manning Boiler

Fig. 17. Wickes Water-tube Boiler

The examples given illustrate, in a general way, the most important types of boilers in use. While there are many makers whose boilers may differ in minor details from those illustrated, the general principles of design and features of construction will be found to be practically the same.



## CHAPTER IV

### DESIGN OF HORIZONTAL TUBULAR BOILERS

There are so many forms of water-tube boilers in use that no attempt will be made to consider their design in detail. The case of the horizontal fire-tube boiler is different, and the engineer should be able to decide upon the general proportions to be employed, rather than leave it to the manufacturers. Although the rating is based on the amount of heating surface, the efficiency will depend to a considerable extent upon its form and general arrangement. The type of riveted joints and the method of bracing are important details, which should be under the general direction of the engineer.

#### Materials

Both wrought-iron and mild steel are used in the construction of boilers, for the shell, tubes, rivets and stays. Cast-iron is only used for man-hole frames and covers, hand-holes, nozzles, and brackets. Wrought-iron and steel are often used for these also, in the best class of work for high pressure boilers.

When wrought-iron plate is used for boiler construction, it should have an ultimate tensile strength varying from 50,000 to 60,000 pounds per square inch; an elongation of 10 to 15 per cent in a test piece 8 inches long; and a contraction of 40 per cent at fracture.

A large proportion of boilers at the present time are made of open-hearth steel. So-called flange steel is generally used for the heads, this being an especially tough and ductile quality of open-hearth steel. The only advantage in the use of wrought-iron plates is their greater ductility, which requires less care in working. The steel used for shells should have a tensile strength varying from 60,000 to 75,000 pounds per square inch, with an elongation of 20 per cent, and a contraction of 50 per cent at fracture. Flange steel for the heads should have a tensile strength of 52,000 to 60,000 pounds per square inch; an elongation of 25 per cent; and a contraction of 45 per cent for plates  $\frac{1}{2}$  inch in thickness, and 40 per cent for  $\frac{3}{4}$ -inch plates.

The braces, if made without welds, are commonly of steel similar to that used for the heads. The rivets are commonly forged from wrought-iron, having a tensile strength of 50,000 pounds, and a shearing strength of 40,000 pounds per square inch of section. They should have an elongation of 18 per cent, and a contraction in area of 40 per cent at fracture. They should stand bending double without fracture when cold, and be capable of being hammered cold to  $\frac{1}{8}$ -inch in thickness without fraying at the edges.

#### Testing the Materials

The meaning of the various terms, relating to strength, used above, are best explained by a brief description of the tests employed for as-

certaining the strength of the materials. Pieces for testing are cut from the side of the plate, of such width that the sectional area shall be approximately 0.4 of a square inch.

The tensile strength is found by pulling the piece apart in a testing machine, and dividing the total force necessary, in pounds, by the sectional area of the test piece. This gives the ultimate or breaking strength in pounds per square inch. To test the elongation, the test piece is placed in the jaws of the machine, and a length of 8 inches marked upon it. It is then pulled apart, and the final length of the marked piece measured. The difference between the original and final lengths, divided by 8, gives the elongation in one inch, from which the percentage of elongation is readily determined. The contraction is found by subtracting the area at the point of fracture from the area before the test was made, and dividing this difference by the original area of the test piece. This quotient multiplied by 100 gives the percentage of contraction and indicates the ductility.

#### Punching and Drilling Plates

When the rivet holes are punched, the metal between the holes is weakened, hence in the best class of work the holes are drilled with the plates in position. In some cases practically the same results are obtained by punching the holes somewhat smaller than required and drilling or reaming them to size afterward.

#### Thickness of Plates

The bursting pressure of a cylindrical shell is found by the following equation

$$p = \frac{2 t S}{d}$$

in which  $p$  = pounds pressure per square inch,

$t$  = thickness of shell plate, in inches,

$S$  = ultimate tensile strength, in pounds per square inch,

$d$  = diameter of shell, in inches.

This formula is for a solid shell without joists; hence, in case of a boiler, the result must be multiplied by the efficiency of the riveted joint used. In practice, the strength of a boiler is also made from five to six times greater than is required for the working pressure, that is, the pressure ordinarily carried is only about one-sixth of the bursting pressure. The margin of strength is called the *factor of safety*. The following table gives the safe working pressures for boilers of different size and thickness of plate, made up with solid plates. To find the safe working pressure in any particular case, multiply the pressure in the table by the efficiency of the joint used.

*Example 1:*—What is the safe working pressure for a 54-inch boiler with  $\frac{3}{8}$ -inch plates, made up with riveted joints having an efficiency of 80 per cent?

The safe pressure from Table VI for solid plates is 130, and for the type of joint used, it is  $130 \times 0.80 = 104$  pounds per square inch.

Example 2:—A boiler 60 inches in diameter is to be made up with riveted joints having an efficiency of 85 per cent, and is to carry a work-

TABLE VI. SAFE WORKING PRESSURES FOR SOLID PLATES  
Factor of Safety, 6. Ultimate tensile strength, 55,000 pounds per square inch.

| Diameter of Shell in Inches | Thickness of Plate in Inches | Safe Working Pressure in Pounds per Square Inch | Diameter of Shell in Inches | Thickness of Plate in Inches | Safe Working Pressure in Pounds per Square Inch |
|-----------------------------|------------------------------|---|-----------------------------|------------------------------|---|
| 42                          | $\frac{5}{16}$               | 137   | 60                          | $\frac{5}{16}$               | 96  |
| 42                          | $\frac{7}{16}$               | 164   | 60                          | $\frac{7}{16}$               | 116   |
| 42                          | $\frac{1}{8}$                | 191   | 60                          | $\frac{1}{8}$                | 134   |
| 42                          | $\frac{1}{4}$                | 220   | 60                          | $\frac{1}{4}$                | 154   |
| 48                          | $\frac{5}{16}$               | 120   | 66                          | $\frac{5}{16}$               | 87  |
| 48                          | $\frac{7}{16}$               | 143   | 66                          | $\frac{7}{16}$               | 104   |
| 48                          | $\frac{1}{8}$                | 170   | 66                          | $\frac{1}{8}$                | 121   |
| 48                          | $\frac{1}{4}$                | 191   | 66                          | $\frac{1}{4}$                | 140   |
| 54                          | $\frac{5}{16}$               | 107   | 72                          | $\frac{5}{16}$               | 80  |
| 54                          | $\frac{7}{16}$               | 130   | 72                          | $\frac{7}{16}$               | 96  |
| 54                          | $\frac{1}{8}$                | 150   | 72                          | $\frac{1}{8}$                | 110   |
| 54                          | $\frac{1}{4}$                | 170   | 72                          | $\frac{1}{4}$                | 130   |

ing pressure of 100 pounds per square inch; what should be the thickness of the shell plates?

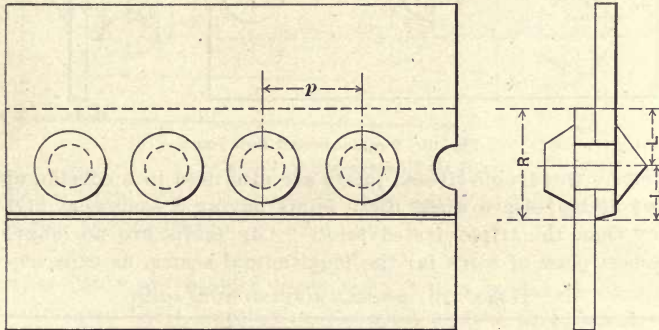

Machinery, N.Y.

Fig. 18. Single-riveted Lap Joint

As the strength of the joints is only 0.85 of the solid plates, we must look in Table VI for a working pressure of  $100 \div 0.85 = 118$

TABLE VII. SINGLE-RIVETED LAP JOINT

| Thickness of Shell Plate | Diameter of Rivets | L              | R              | p              | Efficiency, Per Cent |
|--------------------------|--------------------|----------------|----------------|----------------|----------------------|
| $\frac{5}{16}$           | $\frac{11}{16}$    | $1\frac{1}{8}$ | $2\frac{1}{8}$ | $1\frac{3}{4}$ | 54                   |
| $\frac{7}{16}$           | $\frac{13}{16}$    | $1\frac{1}{4}$ | $2\frac{1}{2}$ | 2              | 55                   |
| $\frac{1}{8}$            | $\frac{15}{16}$    | $1\frac{7}{8}$ | $2\frac{7}{8}$ | $2\frac{1}{4}$ | 56                   |
| $\frac{1}{4}$            | $\frac{1}{8}$      | $1\frac{1}{2}$ | 3              | $2\frac{3}{4}$ | 55                   |

pounds per square inch. We find that a 60-inch boiler with  $\frac{3}{8}$ -inch plates will carry a pressure of 116 pounds, and this would be the thick-

ness to be used. In practice, an additional 1/16 inch is usually allowed to offset the effects of corrosion and add to the life of the boiler. Boiler heads are commonly made 1/8 inch thicker than the shell.

Riveted Joints

The types of joints most commonly used for the longitudinal seams are the double-riveted and triple-riveted butt joints, with double cover-

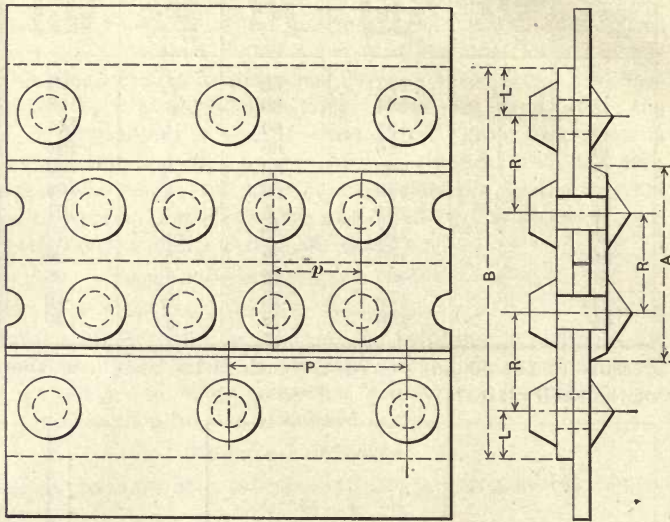

Machinery, N.Y.

Fig. 19. Double-riveted Butt Joint

ing strips. Quadruple-riveted joints are also used to a considerable extent for high-pressure work, these joints having a somewhat higher efficiency than the triple-riveted joint. Lap joints are no longer used in the best class of work for the longitudinal seams, as experience has

TABLE VIII. DOUBLE-RIVETED BUTT JOINT

| Thickness of Shell Plate | Thickness of Cover Plates | Diameter of Rivets | A     | B      | L     | R     | p     | P     | Efficiency, Per Cent |
|--------------------------|---------------------------|--------------------|-------|--------|-------|-------|-------|-------|----------------------|
| 5/16                     | 5/16                      | 3/8                | 4 1/4 | 8 1/2  | 1 1/8 | 2 1/8 | 1 5/8 | 3 1/4 | 80                   |
| 7/16                     | 7/16                      | 1/2                | 5     | 10     | 1 1/4 | 2 1/4 | 2     | 4     | 81                   |
| 1/8                      | 1/8                       | 5/8                | 5 1/4 | 11 1/2 | 1 7/8 | 2 7/8 | 2 3/8 | 4 3/4 | 81                   |
| 1/2                      | 1/2                       | 1 1/8              | 6     | 12     | 1 1/2 | 3     | 2     | 5 1/4 | 82                   |

shown that they become weakened by continued use, and are liable to fracture. Single-riveted lap joints are sufficiently strong for the girth seams, as the pressure exerted in this direction is only one-half that carried by the longitudinal seams.

Fig. 18 shows the details of a single-riveted lap joint, and Table VII

gives the dimensions for different thicknesses of plate. The double-riveted butt joint is shown in Fig. 19 and the dimensions are given

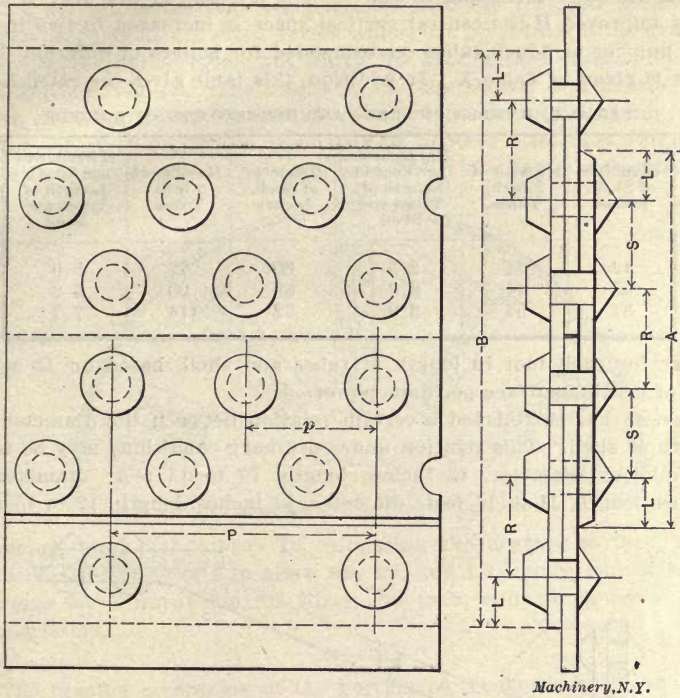

Fig. 20. Triple-riveted Butt Joint

in Table VIII. Fig. 20 shows the triple-riveted butt joint and Table IX gives the dimensions for this joint.

#### Tubes

Boiler tubes are usually made from 3 to 4 inches in diameter, depending upon their length and the kind of fuel to be used. A com-

TABLE IX. TRIPLE-RIVETED BUTT JOINT

| Thickness of Shell Plate | Thickness of Cover Plates | Diameter of Rivets | A               | B               | L              | R              | S              | p              | P              | Efficiency, Per Cent |
|--------------------------|---------------------------|--------------------|-----------------|-----------------|----------------|----------------|----------------|----------------|----------------|----------------------|
| $\frac{5}{16}$           | $\frac{1}{4}$             | $\frac{5}{8}$      | 8               | $12\frac{1}{4}$ | $1\frac{1}{8}$ | $2\frac{1}{8}$ | $1\frac{7}{8}$ | $2\frac{3}{4}$ | $5\frac{1}{2}$ | 88                   |
| $\frac{3}{8}$            | $\frac{1}{2}$             | $\frac{3}{4}$      | $9\frac{1}{4}$  | $14\frac{1}{4}$ | $1\frac{1}{4}$ | $2\frac{1}{2}$ | $2\frac{1}{4}$ | $3\frac{1}{4}$ | $6\frac{1}{4}$ | 90                   |
| $\frac{1}{2}$            | $\frac{3}{4}$             | $\frac{7}{8}$      | $10\frac{1}{2}$ | $16\frac{1}{4}$ | $1\frac{7}{8}$ | $2\frac{7}{8}$ | $2\frac{3}{8}$ | $3\frac{1}{2}$ | 7              | 90                   |
| $\frac{5}{8}$            | $1\frac{1}{8}$            | $1\frac{1}{8}$     | 11              | 17              | $1\frac{1}{2}$ | 3              | $2\frac{1}{2}$ | $3\frac{1}{2}$ | $7\frac{1}{2}$ | 88                   |

mon rule is to allow 1 inch in diameter for each  $5\frac{1}{2}$  feet in length for anthracite coal, and for each  $4\frac{1}{2}$  feet in length for bituminous coal. The number of tubes for a given diameter of shell varies with

different manufacturers. In general, there should be a clear space of 1 inch between the tubes in both directions, and at least 3 inches between the outer tubes and the shell. The circulation will also be somewhat improved if the central vertical space is increased to two inches. The number of 3-inch tubes recommended for boilers of different diameters is given in Table X. In addition, this table gives the rated horse-

TABLE X. NUMBER OF TUBES AND HORSEPOWER OF BOILERS

| Diameter of Shell, Inches | Number of 3-inch Tubes | Horsepower per Foot in Length of Tubes and Shell | Diameter of Shell, Inches | Number of 3-inch Tubes | Horsepower Per Foot in Length of Tubes and Shell |
|---------------------------|------------------------|--|---------------------------|------------------------|--|
| 42                        | 34                     | 2.5  | 60                        | 72                     | 5.0  |
| 48                        | 44                     | 3.2  | 66                        | 90                     | 6.2  |
| 54                        | 54                     | 3.9  | 72                        | 114                    | 7.7  |

power for each foot in length of tubes and shell, based on 12 square feet of heating surface per horsepower.

Custom has established a certain relation between the diameter and length of shell. This relation under ordinary conditions may be taken as follows: Diameter, 42 inches, length, 10 to 13 feet; diameter, 48 inches, length, 11 to 14 feet; diameter, 54 inches, length, 12 to 15 feet;

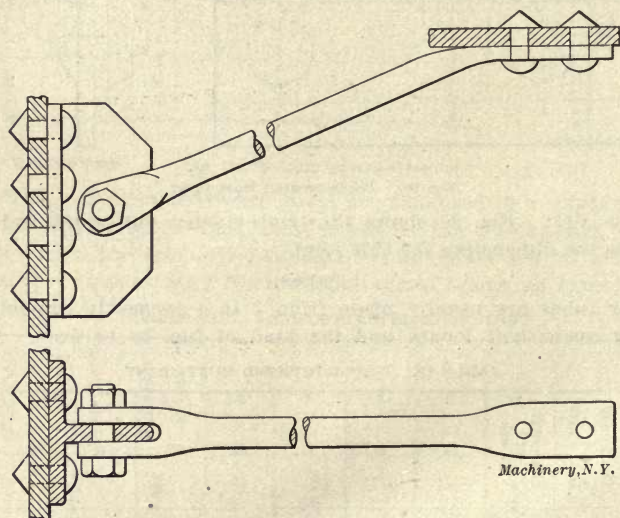

Fig. 21. Diagonal Type Boiler Brace

diameter, 60 inches, length, 13 to 16 feet; diameter, 66 inches, length, 14 to 17 feet; diameter, 72 inches, length, 15 to 18 feet.

*Example 1:*—What is the rated horsepower of a 66-inch boiler with 90 3-inch tubes, 16 feet long? From Table X we find that the horsepower per foot is 6.2; hence  $6.2 \times 16 = 99.2$  horsepower.

*Example 2:*—What should be the dimensions of a 70 horsepower

boiler, using 3-inch tubes? From Table X we find that a section of a 60-inch boiler 1 foot in length is rated at 5 horsepower. Then  $70 \div 5 = 14$  feet, is the required length to give the required horsepower.

The proportions are often varied somewhat according to the available space in the boiler room, but should be kept within certain limits to get the best results. The diagrams of tube sheets, of different diameters, in Figs. 26 to 33, inclusive, show the arrangement for 3-inch tubes. If it is desired to use tubes of another size, they can be arranged to cover about the same area, with the same spaces between

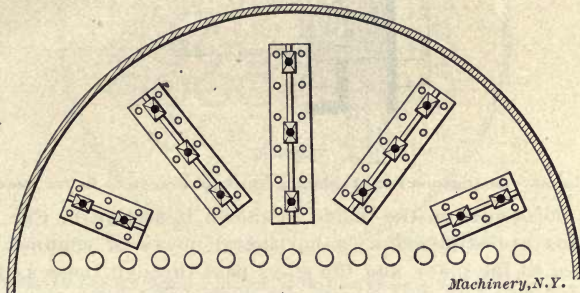

Fig. 22. Arrangement of Tee-irons for Braces

them as for 3-inch tubes. In computing the heating surface, it will be sufficiently accurate to allow 0.8, 0.9, and 1.0 square foot of heating surface for 1 linear foot of 3-inch, 3½-inch, and 4-inch boiler tubes, respectively.

#### Bracing

The bracing or staying of the portion of the heads above the tubes is an important detail in the design and construction of tubular boilers. There are two general methods of doing this, known as "crow-foot" or diagonal bracing and "through" bracing.

The brace shown in Fig. 21 is of the diagonal type. It is provided with a forked head at one end, which is attached to a piece of tee-iron

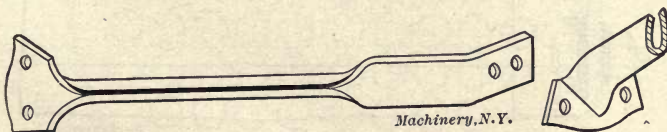

Fig. 23. Solid Boiler Brace of Pressed Steel

riveted to the boiler head. The other end is riveted directly to the shell of the boiler as shown. A common arrangement of the tee-irons, which are riveted to the boiler head, is given in Fig. 22, which shows a design for 13 braces. The brace in Fig. 21 is of an older type, and has been superseded to a considerable extent by the solid brace of pressed steel, one form of which is shown in Fig. 23. This brace is without welds and is riveted directly to the boiler head instead of being attached by means of a tee-iron and pin. Diagonal braces are

largely used in heating boilers and in combination with through bracing in power boilers of medium size. They have the advantage of allowing free access to the boiler by way of a man-hole in the top of the shell.

In the case of through bracing, the stays extend entirely through the boiler and are provided with heavy nuts and washers outside the heads,

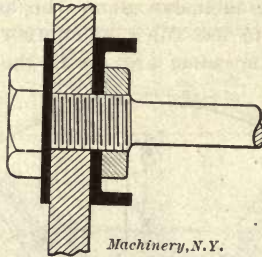

Fig. 24. Arrangement for Fastening Through Braces to Boiler Head

and with check-nuts on the inside as shown in section in Fig. 24. The boiler heads are stiffened with horizontal pieces of channel or angle iron riveted to the plate, and the stays pass through these as indicated in Fig. 24. Through bracing is especially adapted to high-pressure boilers of large size.

A good arrangement for power boilers of medium size, say 54 and 60 inches in diameter, is a combination of through and diagonal bracing,

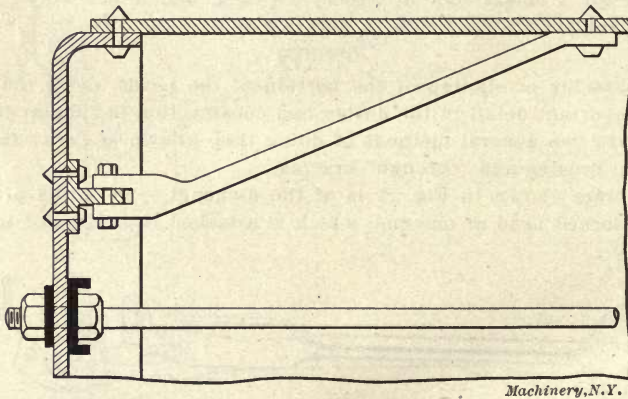

Fig. 25. Combination of Through and Diagonal Braces

ing, as shown in Fig. 25. Three or four through braces are carried across above the tubes in a horizontal line, and the remaining portion of the head above these is supported by diagonal stays. The advantage of this arrangement consists in better access to the interior of the boiler for inspection.

#### Design of Tube Sheets

The design of the tube sheet includes the arrangement of the tubes and bracing, and can best be shown by detail drawings for boilers of



standard sizes. The computations for this part of the work are somewhat complicated, especially for through bracing, and can hardly be

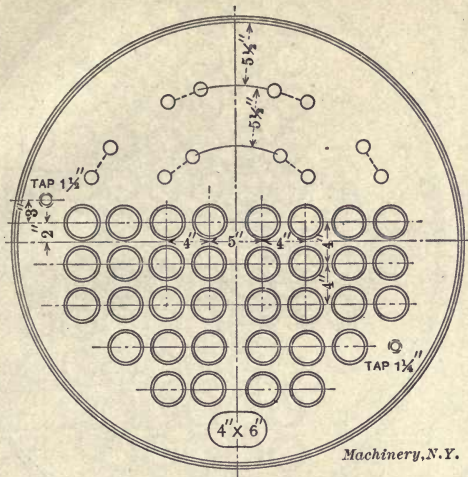

Fig. 26. Forty-two-inch Diameter Boiler, with 34 Tubes, 3 Inches in Diameter, and Six 1 1/8-inch Braces. Least Angle Brace makes with Boiler-head is 70 Degrees

given in proper form in a treatise of limited space. Tube sheets with diagonal bracing are shown in Figs. 26 to 29, for boilers from 42 to 60

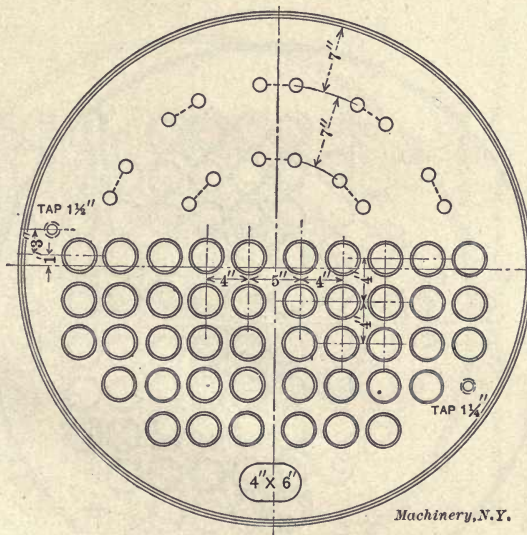

Fig. 27. Forty-eight-inch Diameter Boiler, with 44 Tubes, 3 Inches in Diameter, and Eight 1 1/8-inch Braces. Least Angle Brace makes with Boiler-head is 70 Degrees

inches in diameter, and tube sheets with through bracing in Figs. 30 to 33 for boilers from 54 to 72 inches in diameter. Combination bracing

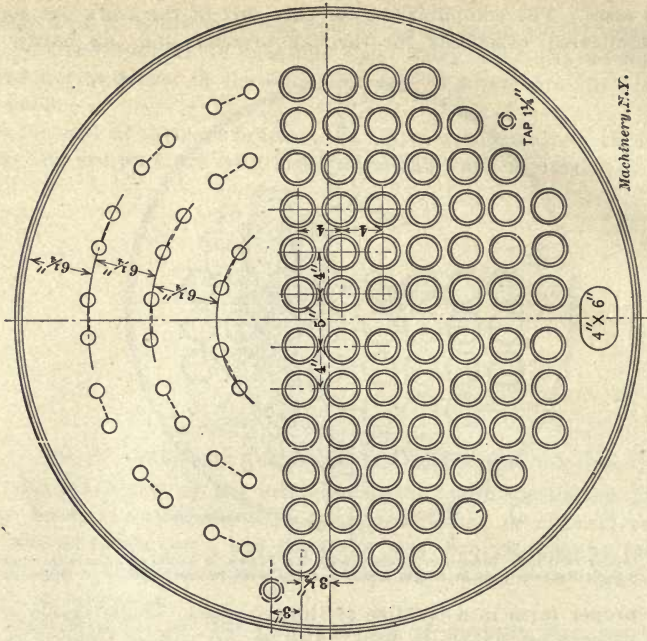

Fig. 29. Sixty-inch Diameter Boiler with 72 Tubes, 3 Inches in Diameter, and Fourteen 1 1/8-inch Braces. Least Angle Brace makes with Boiler-head is 70 Degrees

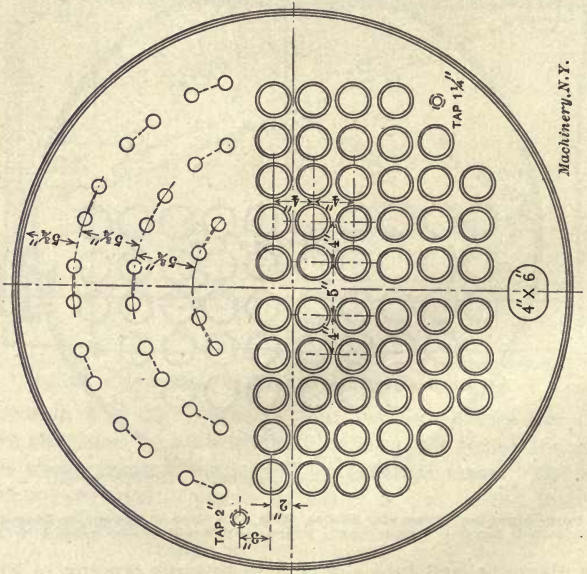

Fig. 28. Fifty-four-inch Diameter Boiler, with 54 Tubes, 3 Inches in Diameter, and Fourteen 1 1/8-inch Braces. Least Angle Brace makes with Boiler-head is 70 Degrees

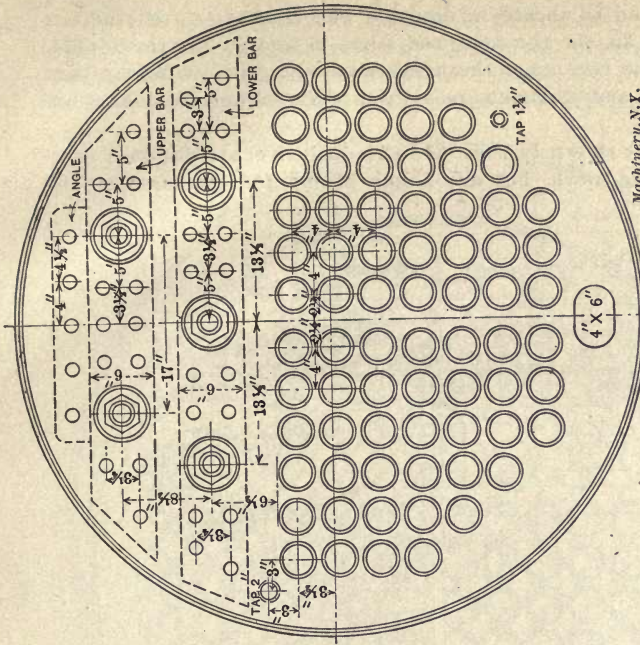

Fig. 31. Sixty-inch Boiler with 72 Tubes, 3 inches in Diameter

For 100 Pounds Pressure: Angle, 3 x 3 x 5-8 inch; long flange riveted to head. Upper and lower bars, 6 x 2.39 x 0.52 inch channels. Diameter of rivets for channels and angle, 13-16 inch. Diameter of stays, 1 1/2 inch. Ends upset to 2 inches. Diameter of washers, 5 inches. Thickness of washers, 1 inch.

For 150 Pounds Pressure: Angle, 3 x 3 x 1-2 inch. Upper and lower bars, 3 x 3 x 1-2 inch angles, two for each; long flanges riveted to head. Rivets and washers, same as above. Diameter of stays, 1 1/2 inch. Ends upset to 2 3/4 inches.

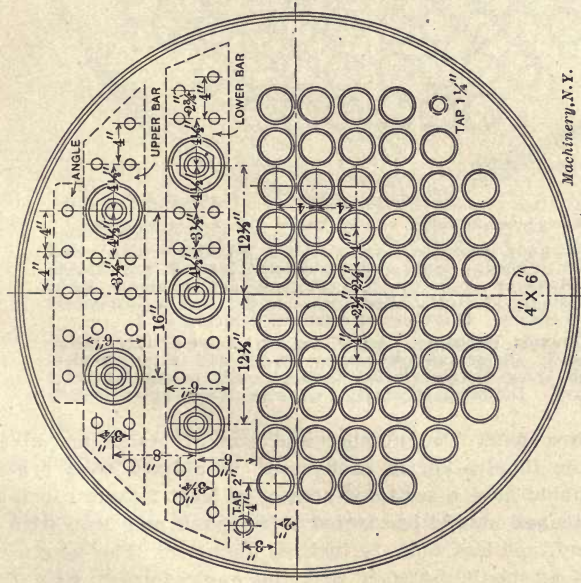

Fig. 30. Fifty-four-inch Boiler with 54 Tubes, 3 inches in Diameter

For 100 Pounds Pressure: Angle, 3 x 2 1/2 x 9-16 inch; long flange riveted to head. Upper and lower bars, 6 x 2.39 x 0.52 inch channels. Diameter of rivets for channels and angle, 13-16 inch. Diameter of stays, 1 1/2 inch. Ends upset to 2 inches. Diameter of washers, 5 inches. Thickness of washers, 1 inch.

For 150 Pounds Pressure: Angle, same as above. Upper and lower bars, 3 x 2 1/2 x 9-16 inch angles, two for each; long flanges riveted to head. Rivets and washers, same as above. Diameter of stays, 1 3/4 inch. Ends upset to 2 1/4 inches.

for boilers 54 and 60 inches in diameter can be made up by the use of Figs. 28 and 30, for the first, and Figs. 29 and 31 for the second. In doing this, the two upper through braces with their stiffening bars may be omitted, and diagonal braces from Figs. 28 and 29 substituted in their places.

The tube sheets shown in Figs. 26 to 29, inclusive, are designed especially for heating work, but are amply strong for pressures of 100

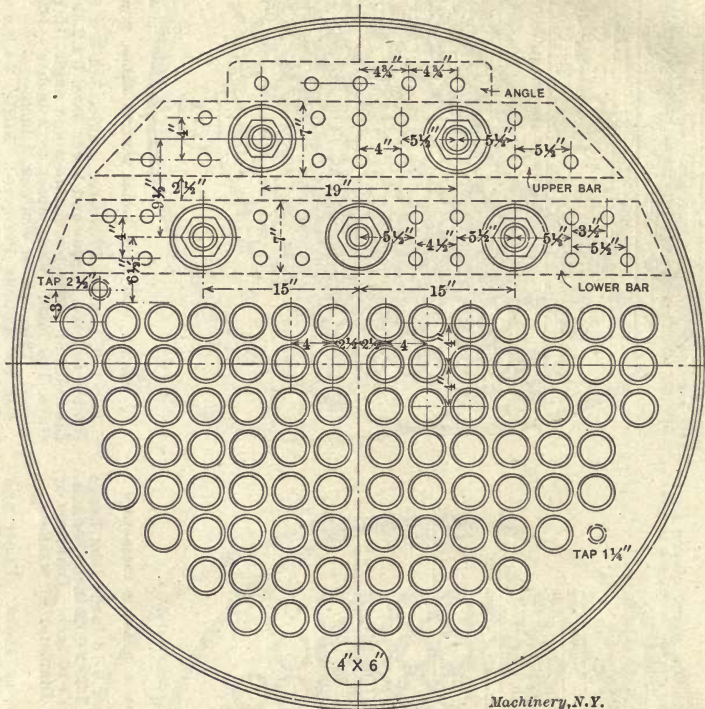

Fig. 32. Sixty-six-inch Boiler with 90 Tubes, 3 Inches in Diameter

For 100 Pounds Pressure: Angle,  $3\frac{1}{2} \times 3 \times 13-16$  inch; long flange riveted to head. Upper and lower bars,  $7 \times 2.67 \times 0.57$  inch channels. Diameter of rivets for channels and angle, 1 inch. Diameter of stays,  $1\frac{3}{4}$  inch. Ends upset to  $2\frac{1}{4}$  inches. Diameter of washers, 6 inches. Thickness of washers, 1 inch.

For 150 Pounds Pressure: Angle,  $3 \times 3 \times 1-2$  inch; long flange riveted to head. Upper and lower bars,  $3\frac{1}{2} \times 3 \times 13-16$  inch angles, two for each; long flanges riveted to head. Rivets and washers, same as above. Diameter of stays,  $2\frac{1}{8}$  inch. Ends upset to  $2\frac{3}{8}$  inches.

pounds per square inch. The number and size of braces are given directly below the illustration in each case. If pressed steel braces are used, they should have a sectional-area of at least 1 square inch at the weakest point, and should be riveted to the shell and head with 2 rivets at each end, not less than  $\frac{7}{8}$  inch in diameter. The length of all diagonal braces should be such that the angle formed with the head shall not be less than 70 degrees.

The tube sheets shown in Figs. 30 to 33, inclusive, are designed for high pressure work, dimensions being given directly below the illustrations for working pressures of 100 and 150 pounds per square inch. When combination bracing is used, as previously described, pres-

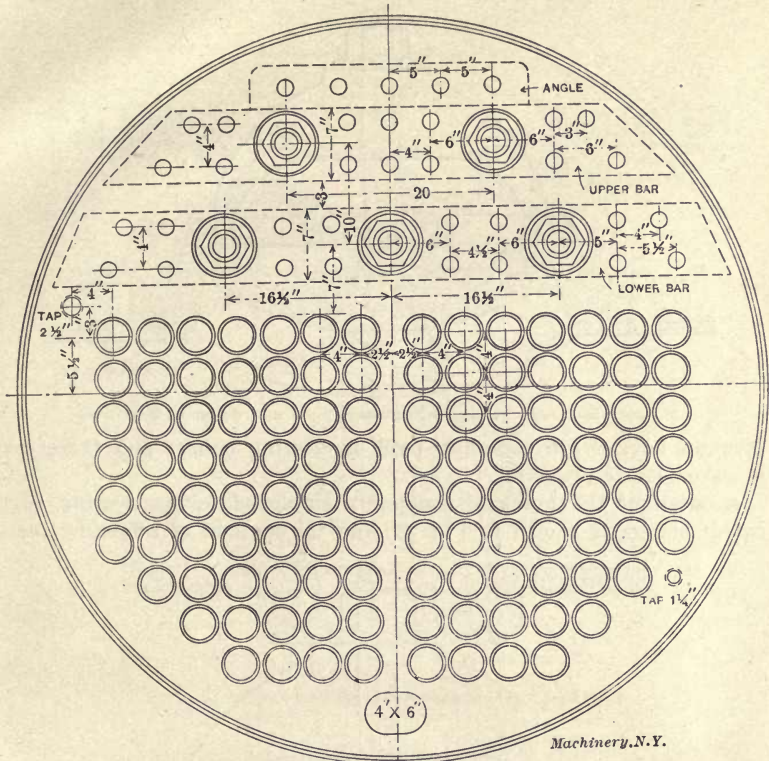

Fig. 33. Seventy-two-inch Boiler with 114 Tubes, 3 Inches in Diameter

For 100 Pounds Pressure: Angle,  $3\frac{1}{2} \times 3 \times 13-16$  inch; long flange riveted to head. Upper and lower bars,  $3\frac{1}{2} \times 2\frac{1}{2} \times 11-16$  inch angles, two for each; long flanges riveted to head. Diameter of rivets for angles, 1 inch. Diameter of stays,  $1\frac{1}{4}$  inch. Ends upset to  $2\frac{1}{4}$  inches. Diameter of washers, 6 inches. Thickness of washers, 1 inch.

For 150 Pounds Pressure: Angle, same as above. Upper and lower bars,  $3\frac{1}{2} \times 3 \times 13-16$  inch angles, two for each; long flanges riveted to head. Rivets and washers same as above. Diameter of stays  $2\frac{1}{4}$  inches. Ends upset to  $2\frac{7}{8}$  inches.

tures should not be carried much above 100 pounds, unless additional diagonal braces are added.

#### Fittings

Boiler fittings include man-holes, hand-holes, nozzles, and brackets. Three types of man-holes are shown in Figs. 34, 35, and 36. In the first two, the frames, yokes and covers are of cast iron, while the third is of pressed steel. A common form of cast-iron hand-hole with

plate and yoke is shown in Fig. 37. Standard man-holes are made 11 by 15 inches in size, of oval form. Hand-holes are commonly 4 by 6 inches in size. The tapered nozzle, shown in Fig. 38, is a good form for high-pressure work as it offers less resistance to the flow of steam.

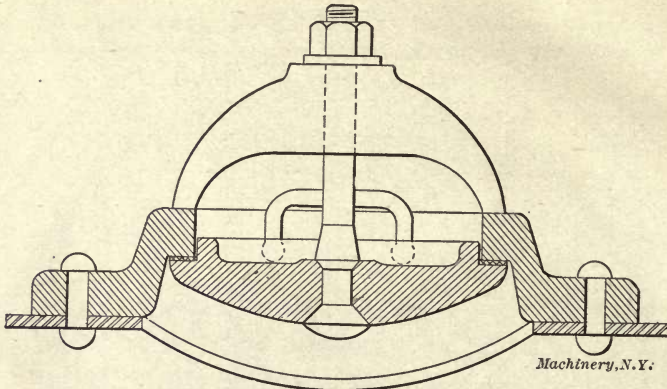

Fig. 34. Man-hole Design with Frame, Yoke and Cover of Cast Iron

Straight nozzles are generally used on heating boilers and those carrying moderate pressures.

A detail of the brackets commonly employed for supporting horizontal boilers is shown in Fig. 41, and the method of attaching them

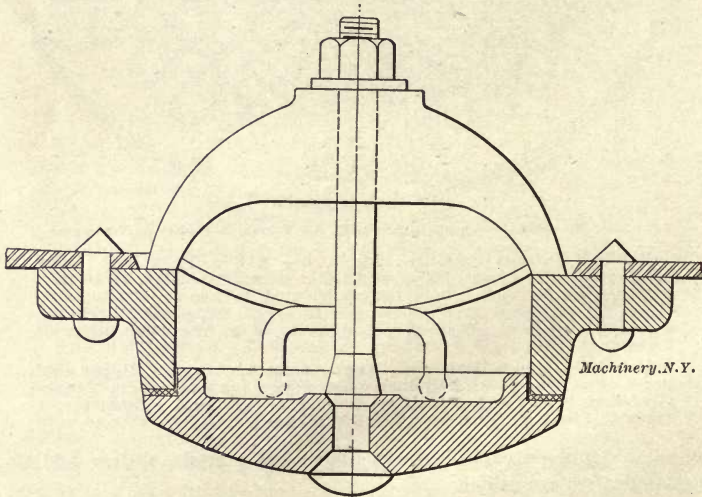

Fig. 35. Another Type of Man-hole Design

to the boiler shell in Fig. 3. In the case of boilers of small and medium size, two brackets are used on each side, but for those of large size, it is customary to arrange them in pairs, four on each side, as in Fig. 3. Manufacturers commonly have standard patterns for

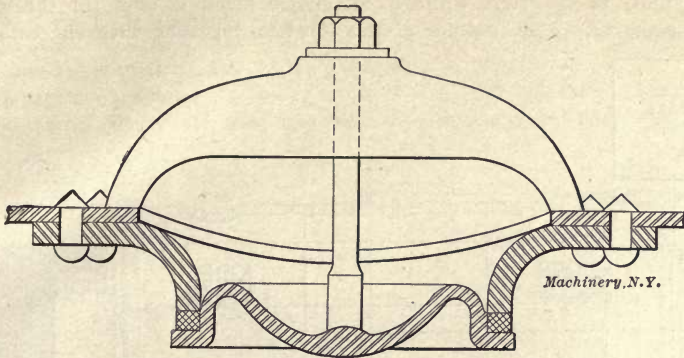

Fig. 36. Man-hole Design with Frame, Yoke and Cover of Pressed Steel

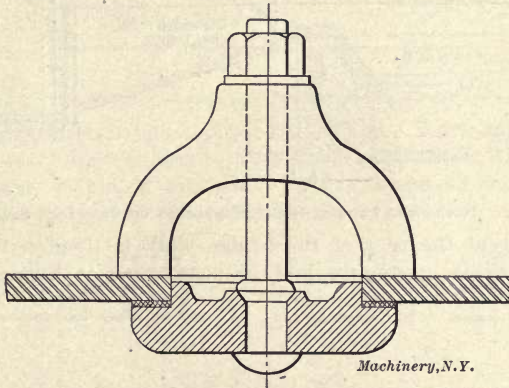

Fig. 37. Common Type of Hand-hole Yoke and Plate

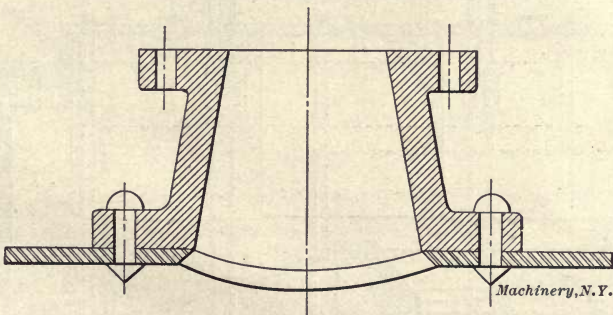

Fig. 38. Tapered Nozzle for High-pressure Boilers

the various fittings used, so that the engineer is not called upon to design these details except in special cases.

#### Boiler Settings

Horizontal tubular boilers require a brick setting of the general form shown in longitudinal section in Figs. 39 and 40. The foundation

is usually of concrete, while hard burned brick is used for the walls and covering. The interior of the furnace, together with the combus-

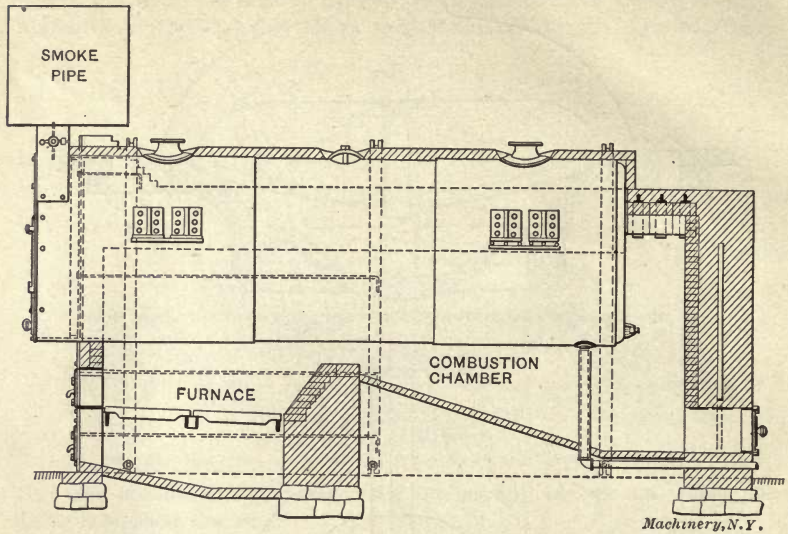

Fig. 39. Horizontal Tubular Boiler Supported on Cast Iron Brackets

tion chamber at the rear of the bridge wall, is lined with fire-brick. The red brick is commonly laid in a mixture of cement and lime

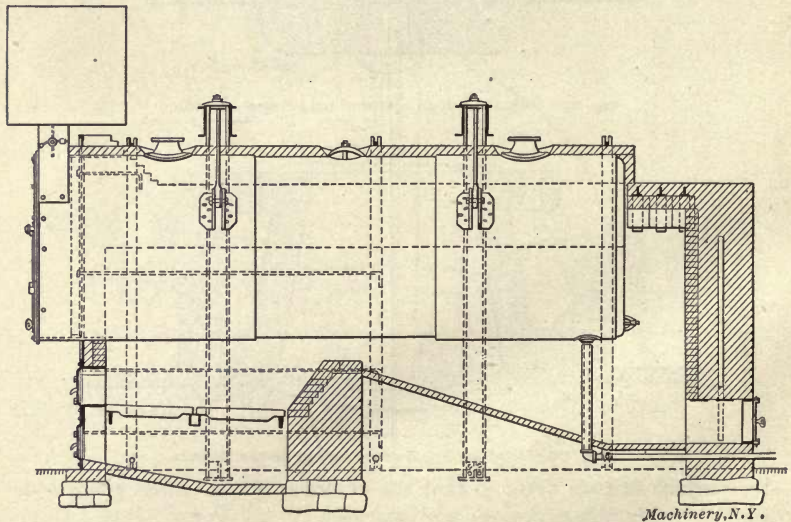

Fig. 40. Boiler Suspended on Cast Iron Brackets

mortar, and the fire-brick in pure cement or fire-clay, with very close joints. In Fig. 39 the boiler is supported upon cast-iron lugs or



brackets resting upon the side walls of the setting. Iron plates are built into the brick-work for the lugs to rest upon, the forward pair being stationary while the rear pair is provided with rollers to secure an easy movement as the boiler expands and contracts.

An approved setting for power work, where very hot fires are carried, is shown in Fig. 40. In this case the boiler is suspended from overhead

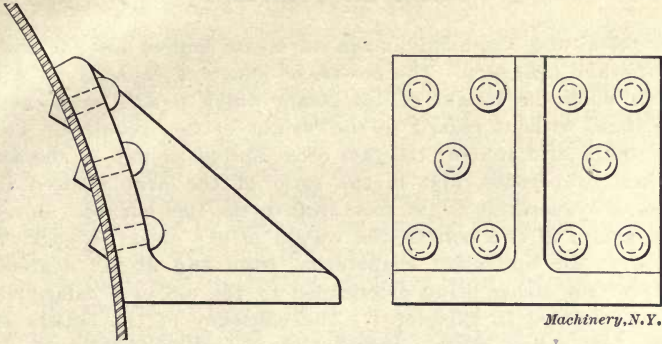
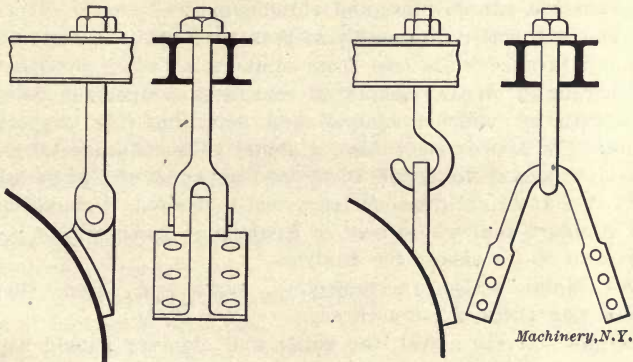

Fig. 41. Bracket Commonly used for Supporting Horizontal Boilers

girders and the weight taken from the setting. When set in this way, cracks are less likely to occur in the brick-work than when the walls also carry the weight of the boiler. Figs. 42 and 43 show details for attaching the hangers to the boiler shell.



Figs. 42 and 43. Methods of Attaching Hangers to Boiler Shell

In the case of power boilers set as shown in Fig. 39, the outer walls are usually made 26 inches in thickness, consisting of a 16-inch inner wall, a 2-inch air space, and an 8-inch outer wall. Sometimes the outer wall is made 12 inches for the larger sizes. In the case of heating boilers, the walls are made somewhat lighter, the inner wall being 12 inches for sizes up to and including 54 inches, while 8-inch outer walls may be used for all sizes. When the boilers are suspended, lighter walls answer all requirements. Two 8-inch walls with a 2-inch air space are then used for boilers up to 54 inches in diameter, and a 12-inch inner wall, a 2-inch air space, and an 8-inch outer wall for larger sizes.

## CHAPTER V

### BOILER TESTING

The tests most commonly made on steam boilers are for *steaming capacity*, and *efficiency*. The power, or steaming capacity, of a boiler depends upon the weight of dry steam which it will evaporate in a given time, without regard to the weight of fuel required. The efficiency takes into account the fuel consumption as well as the amount of steam evaporated, and is the ratio of the heat utilized in the process of evaporation to the total heat in the fuel burned. In making a comparison of two boilers, the weight of dry steam in each case is reduced to an equivalent evaporation from and at 212 degrees, the quality of the steam being determined by the use of a calorimeter as previously stated in Chapter I. The efficiency of the boilers should be given due weight when comparing the operation of the two.

#### General Rules

Before starting a test, certain data should be obtained, and various preliminaries attended to, as noted below:

1.—Measure and record the following dimensions: grate surface, heating surface, smoke pipe, and chimney.

2.—Clean the boiler thoroughly of both soot and scale, and have the grates and furnace walls free from clinkers.

3.—Thoroughly dry a sample of coal, and compare its volume for volume with an undried sample, and determine the proportion of moisture. For approximate tests, a pound of best anthracite coal may be assumed to contain 14,000 T. U., and a pound of Cumberland coal 12,500 T. U. If an accurate efficiency test is desired, it should be made with a standard coal whose heat of combustion is known, or a sample may be sent to an expert for analysis.

4.—All tanks, scales, thermometers, gages, etc., used, should be examined and checked for accuracy.

5.—Before starting a test, the boiler and chimney should be heated to their usual working temperature. In case of a new plant, the fires should be run for at least a week before making the test.

6.—All steam and water connections should be examined and made tight, and the main steam pipe so graded that no condensation can drain back into the boiler. If fed by an injector, the steam for operating it should be taken from the boiler being tested.

In the accepted method of testing, steam is raised to the normal working pressure, the fire drawn and all refuse removed from the ash-pit. A new fire is then started, a record being kept of the weight of all fuel used for this purpose. At the end of the test the fire is again drawn and the ash-pit cleaned as at the beginning.

In an alternate method the fire is allowed to burn rather low, and is then thoroughly cleaned; the amount of coal left on the grate at this time is carefully estimated. At the close of the test the fire should be brought to practically the same condition as at the start. With either method, the steam pressure and water level should be the same at the beginning and close of the test, and should be maintained as nearly uniform as possible throughout the run.

For simple tests which are carried on under regular working conditions the last described method is to be preferred. For accurate tests the run should be continued for at least twenty-four hours, but for approximate work a full day of eight or ten hours will give very good results. The coal used during the test is usually weighed in barrels, the net weight being accurately recorded, and any which is unused at the end of the run being deducted from the total.

The feed-water may be measured by a meter, if the accuracy of this has been tested by weighing the water which has passed through it in a given time and the results compared with the reading of the meter. If there is no meter, or if its accuracy has not been tested, the water used during the test may be weighed in barrels. The quality of the steam should be taken at frequent intervals during the test; and the weight of feed water used, multiplied by the average quality of the steam, will give the total weight of dry steam evaporated. The temperature of the feed water is usually taken by means of an oil-cup thermometer screwed into the feed pipe near the boiler. The temperature of the feed water and the quality of the steam should be taken once in fifteen minutes, if fairly uniform, and oftener if there is considerable variation.

The chimney draft is measured in inches of water by means of a U-tube, one end of which is connected with the chimney by means of a rubber tube, and the other open to the atmosphere. The method of working up the report is best shown by a practical example.

#### Data

Heating surface, 2000 square feet.  
Grate area, 40 square feet.  
Ratio of grate area to heating surface, 1 to 50.  
Kind of fuel, anthracite coal.  
Length of run, 10 hours.  
Rated horsepower, 200.

#### From Observation

Average steam pressure, 100 pounds (gage).  
Chimney draft, 0.2 inch water.  
Temperature of feed water, 50 degrees F.  
Pounds of coal burned, 6300.  
Amount of moisture in coal, 5 per cent.  
Pounds of refuse, 500.  
Pounds of water fed to boiler, 63,000.  
Quality of steam from calorimeter, 98 per cent (average for test).

## Computed

Pounds of dry coal burned,  $6300 \times 0.95 = 5985$ .

Pounds of combustible,  $5985 - 500 = 5485$ .

Proportion of refuse,  $500 \div 5985 = 0.083$ , or 8.3 per cent.

Coal burned per hour,  $5985 \div 10 = 598.5$  pounds.

Coal burned per square foot of grate area per hour,  $598.5 \div 40 = 15$  pounds.

Total weight of dry steam,  $63,000 \times 0.98 = 61,740$  pounds.

Water actually evaporated per pound of coal,  $61,740 \div 5985 = 10.3$  pounds.

Water actually evaporated per pound of combustible,  $61,740 \div 5485 = 11.25$  pounds.

Factor of evaporation for conditions of test, 1.2.

Water actually evaporated per pound of coal from and at 212 degrees,  $10.3 \times 1.2 = 12.36$  pounds.

Water actually evaporated per pound of combustible from and at 212 degrees,  $11.25 \times 1.2 = 13.5$  pounds.

Horsepower developed during test  $= \frac{61,740 \times 1.2}{10 \times 34.5} = 215$ .

## Efficiency

Assuming each pound of the grade of coal used to contain 14,000 T. U., the total heat given up by the coal is  $5985 \times 14,000 = 83,790,000$  T. U. The total heat absorbed by the boiler equals:

$61,740$  (pounds of water evaporated under actual conditions)  $\times 1.2$  (factor of evaporation)  $\times 966$  (heat of evaporation at 212 degrees)  $= 71,569,000$ , which corresponds to an efficiency of

$71,569,000 \div 83,790,000 = 0.854$  or 85.4 per cent.

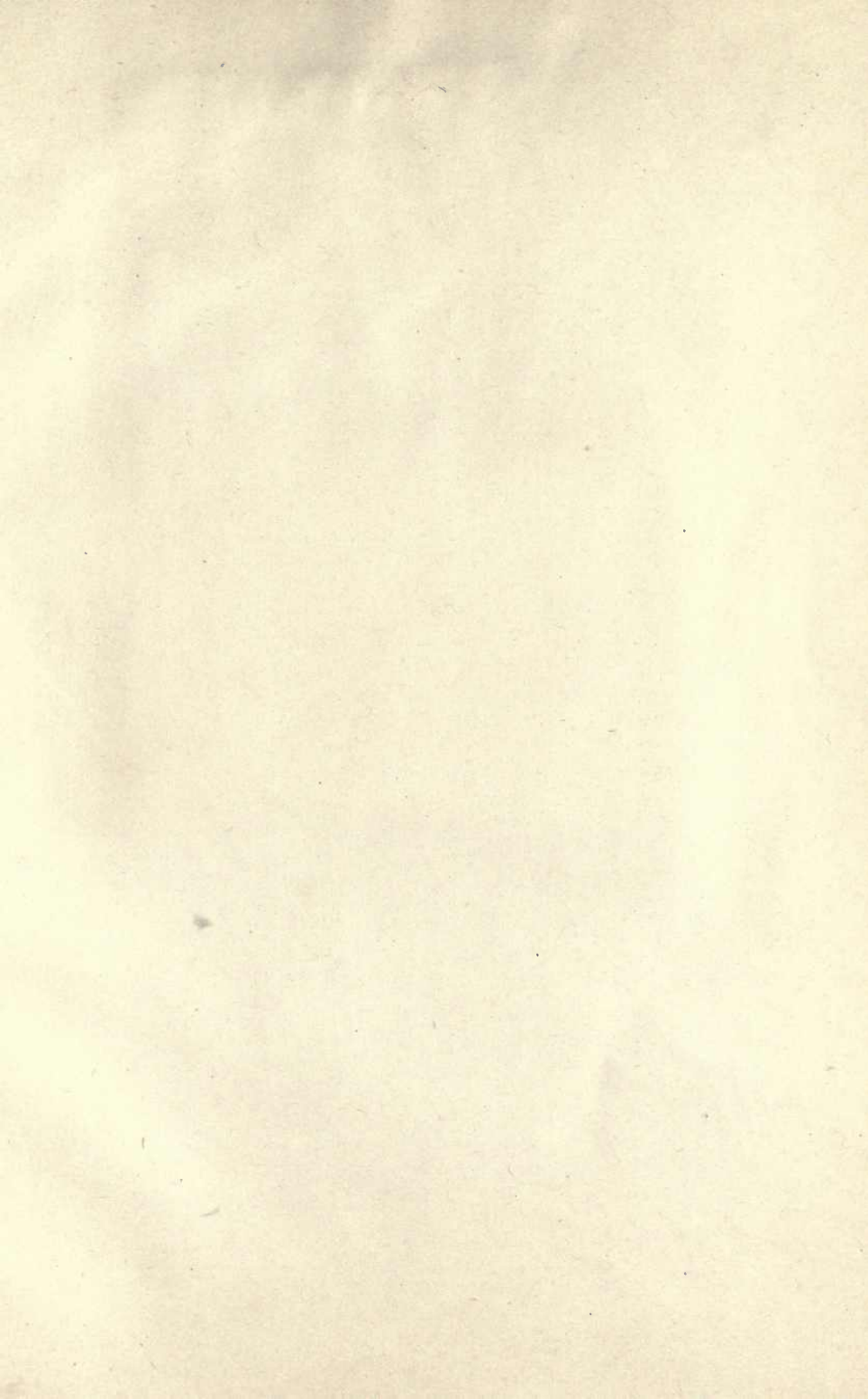

THIS BOOK IS DUE ON THE LAST DATE  
STAMPED BELOW

AN INITIAL FINE OF 25 CENTS  
WILL BE ASSESSED FOR FAILURE TO RETURN  
THIS BOOK ON THE DATE DUE. THE PENALTY  
WILL INCREASE TO 50 CENTS ON THE FOURTH  
DAY AND TO \$1.00 ON THE SEVENTH DAY  
OVERDUE.

APR 10 1935

JUL 23 1938

REC. CIR. NOV 3 '78

SEP 28 1986

AUTO. DISC. JAN 9 '87

FEB 22 1944

3 Jan '50 H J N

25 JL '55 I W

JUL 11 1955 LU

*Neil Ross*  
22 May '60 M J

6/9  
REC'D LD

JUN 10 1960

NOV 14 1978

YC 53944

GENERAL LIBRARY - U.C. BERKELEY



8000860230

TJ7

M3

v67

347621

*machinery's*

UNIVERSITY OF CALIFORNIA LIBRARY

## CONTENTS OF DATA SHEET BOOKS

**No. 1. Screw Threads.**—United States, Whitworth, Sharp V- and British Association Standard Threads; Briggs' Pipe Thread; Oil Well Casing Gages; Fire Hose Connections; Acme Thread; Worm Threads; Metric Threads; Machine, Wood, and Lag Screw Threads; Carriage Bolt Threads, etc.

**No. 2. Screws, Bolts and Nuts.**—Fillet-head, Square-head, Headless, Collar-head and Hexagon-head Screws; Standard and Special Nuts; T-nuts, T-bolts and Washers; Thumb Screws and Nuts; A. L. A. M. Standard Screws and Nuts; Machine Screw Heads; Wood Screws; Tap Drills; Lock Nuts; Eye-bolts, etc.

**No. 3. Taps and Dies.**—Hand, Machine, Tapper and Machine Screw Taps; Taper Die Taps; Sellers Hobs; Screw Machine Taps; Straight and Taper Boiler Taps; Stay-bolt, Washout, and Patch-bolt Taps; Pipe Taps and Hobs; Solid Square, Round Adjustable and Spring Screw Threading Dies.

**No. 4. Reamers, Sockets, Drills and Milling Cutters.**—Hand Reamers; Shell Reamers and Arbors; Pipe Reamers; Taper Pins and Reamers; Brown & Sharpe, Morse and Jarno Taper Sockets and Reamers; Drills; Wire Gages; Milling Cutters; Setting Angles for Milling Teeth in End Mills and Angular Cutters, etc.

**No. 5. Spur Gearing.**—Diametral and Circular Pitch; Dimensions of Spur Gears; Tables of Pitch Diameters; Odontograph Tables; Rolling Mill Gearing; Strength of Spur Gears; Horsepower Transmitted by Cast-iron and Rawhide Pinions; Design of Spur Gears; Weight of Cast-iron Gears; Epicyclic Gearing.

**No. 6. Bevel, Spiral and Worm Gearing.**—Rules and Formulas for Bevel Gears; Strength of Bevel Gears; Design of Bevel Gears; Rules and Formulas for Spiral Gearing; Tables Facilitating Calculations; Diagram for Cutters for Spiral Gears; Rules and Formulas for Worm Gearing, etc.

**No. 7. Shafting, Keys and Keyways.**—Horsepower of Shafting; Diagrams and Tables for the Strength of Shafting; Forcing, Driving, Shrinking and Running Fits; Woodruff Keys; United States Navy Standard Keys; Gib Keys; Milling Keyways; Duplex Keys.

**No. 8. Bearings, Couplings, Clutches, Crane Chain and Hooks.**—Pillow Blocks; Babbitted Bearings; Ball and Roller Bearings; Clamp Couplings; Plate Couplings; Flange Couplings; Tooth Clutches; Crab Couplings; Cone Clutches; Universal Joints; Crane Chain; Chain Friction; Crane Hooks; Drum Scores.

**No. 9. Springs, Slides and Machine Details.**—Formulas and Tables for Spring Calculations; Machine Slides; Machine Handles and Levers; Collars; Hand Wheels; Pins and Cotters; Turn-buckles, etc.

**No. 10. Motor Drive, Speeds and Feeds, Change Gearing, and Boring Bars.**—Power required for Machine Tools; Cutting Speeds and Feeds for Carbon and High-speed Steel; Screw Machine Speeds and Feeds; Heat Treatment of High-speed

Steel Tools; Taper Turning; Change Gearing for the Lathe; Boring Bars and Tools, etc.

**No. 11. Milling Machine Indexing, Clamping Devices and Planer Jacks.**—Tables for Milling Machine Indexing; Change Gears for Milling Spirals; Angles for setting Indexing Head when Milling Clutches; Jig Clamping Devices; Straps and Clamps; Planer Jacks.

**No. 12. Pipe and Pipe Fittings.**—Pipe Threads and Gages; Cast-iron Fittings; Bronze Fittings; Pipe Flanges; Pipe Bends; Pipe Clamps and Hangers; Dimensions of Pipe for Various Services, etc.

**No. 13. Boilers and Chimneys.**—Flue Spacing and Bracing for Boilers; Strength of Boiler Joints; Riveting; Boiler Setting; Chimneys.

**No. 14. Locomotive and Railway Data.**—Locomotive Boilers; Bearing Pressures for Locomotive Journals; Locomotive Classifications; Rail Sections; Frogs, Switches and Cross-overs; Tires; Tractive Force; Inertia of Trains; Brake Levers; Brake Rods, etc.

**No. 15. Steam and Gas Engines.**—Saturated Steam; Steam Pipe Size; Steam Engine Design; Volume of Cylinders; Stuffing Boxes; Setting Corliss Engine Valve Gears; Condenser and Air Pump Data; Horsepower of Gasoline Engines; Automobile Engine Crankshafts, etc.

**No. 16. Mathematical Tables.**—Squares of Mixed Numbers; Functions of Fractions; Circumference and Diameters of Circles; Tables for Spacing off Circles; Solution of Triangles; Formulas for Solving Regular Polygons; Geometrical Progression, etc.

**No. 17. Mechanics and Strength of Materials.**—Work; Energy; Centrifugal Force; Center of Gravity; Motion; Friction; Pendulum; Falling Bodies; Strength of Materials; Strength of Flat Plates; Ratio of Outside and Inside Radii of Thick Cylinders, etc.

**No. 18. Beam Formulas and Structural Design.**—Beam Formulas; Sectional Moduli of Structural Shapes; Beam Charts; Net Areas of Structural Angles; Rivet Spacing; Splices for Channels and I-beams; Stresses in Roof Trusses, etc.

**No. 19. Belt, Rope and Chain Drives.**—Dimensions of Pulleys; Weights of Pulleys; Horsepower of Belting; Belt Velocity; Angular Belt Drives; Horsepower transmitted by Ropes; Sheaves for Rope Drive; Bending Stresses in Wire Ropes; Sprockets for Link Chains; Formulas and Tables for Various Classes of Driving Chain.

**No. 20. Wiring Diagrams, Heating and Ventilation, and Miscellaneous Tables.**—Typical Motor Wiring Diagrams; Resistance of Round Copper Wire; Rubber Covered Cables; Current Densities for Various Contacts and Materials; Centrifugal Fan and Blower Capacities; Hot Water Main Capacities; Miscellaneous Tables; Decimal Equivalents; Metric Conversion Tables, Weights and Specific Gravity of Metals, Weights of Fillets, Drafting-room Conventions, etc.

MACHINERY, the monthly mechanical journal, originator of the Reference and Data Sheet Series, is published in four editions—the *Shop Edition*, \$1.00 a year; the *Engineering Edition*, \$2.00 a year; the *Railway Edition*, \$2.00 a year, and the *Foreign Edition*, \$3.00 a year.

The Industrial Press, Publishers of MACHINERY,  
49-55 Lafayette Street, New York City, U. S. A.